

TOSHIBA

Leading Innovation >>>

3 CCD COLOR CAMERA

INSTRUCTION MANUAL

IK-TF5P2

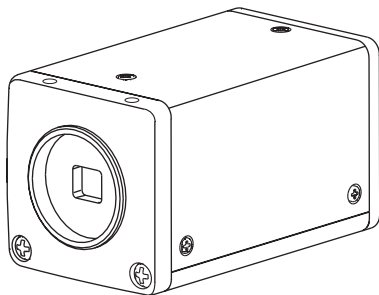

For Customer Use

Enter below the Serial No. which is located on the bottom of the cabinet. Retain this information for future reference.

Model No.: IK-TF5P2

Serial No.: _____

FCC NOTICE

This equipment has been tested and found to comply with the limits for a Class A digital device, pursuant to Part 15 of the FCC Rules. These limits are designed to provide reasonable protection against harmful interference when the equipment is operated in a commercial environment. This equipment generates, uses, and can radiate radio frequency energy and, if not installed and used in accordance with the instruction manual, may cause harmful interference to radio communications. Operation of this equipment in a residential area is likely to cause harmful interference in which case the user will be required to correct the interference at his own expense.

USER-INSTALLER CAUTION: Your authority to operate this FCC verified equipment could be voided if you make changes or modifications not expressly approved by the party responsible for compliance to Part 15 of the FCC Rules.

This Class A digital apparatus complies with Canadian ICES-003.

Cet appareil numérique de la classe A est conforme à la norme NMB-003 du Canada.

Following information is only for EU-member states:

In residential areas this product may cause radio interference, therefore this product must not be used in residential areas.

Following information is only for EU-member states:

The use of the symbol indicates that this product may not be treated as household waste. By ensuring this product is disposed of correctly, you will help prevent potential negative consequences for the environment and human health, which could otherwise be caused by inappropriate waste handling of this product. For more detailed information about the take-back and recycling of this product, please contact your supplier where you purchased the product or consult.



SAFETY PRECAUTIONS

Safety icons

This manual contains safety instructions that must be observed in order to avoid potential hazards that could result in personal injuries, damage to your equipment, or loss of data.

These safety cautions have been classified according to the seriousness of the risk, and the icons highlight these instructions as follows:

▲ WARNING Indicates a potentially hazardous situation which, if not avoided, could result in death or serious injury.

▲ CAUTION Indicates a potentially hazardous situation which, if not avoided, may result in minor or moderate injury.

CAUTION Indicates a potentially hazardous situation which, if not avoided, may result in property damage.

▲ WARNING **Stop operation immediately if any abnormality or defect occurs.**
Use during an abnormal condition; such as emitting smoke, burning odors, damage from dropping, invasion of foreign objects, etc. may result in fire and/or electric shock. Immediately disconnect the power source and contact your dealer.

▲ WARNING **Avoid installing in a shower room or a bathroom.**
This may result in fire and/or electric shock.

▲ WARNING **Do not operate in places where the product may get wet.**
This may result in fire and/or electric shock.

▲ WARNING **Do not repair, disassemble and/or modify by yourself.**
This may result in fire and/or electric shock. Be always sure to contact your dealer for internal repair, check and cleaning of the product.

▲ WARNING **Use the specified power supply.**
Otherwise, fire or electrical shock may occur.

▲ WARNING **Do not place anything on top of the unit.**
Foreign materials, such as metals or liquids into the product may result in fire and/or electrical shock.

▲ WARNING **Do not put the product on an unstable, slanted on vibrating surface.**
The product dropping or falling may cause serious injury.

▲ WARNING **Do not touch the product or any connection cables during a thunderstorm.**
This may result in shock.

CAUTION**Note the following instructions when installing.**

- Do not cover the product with any material.
- Do not place the product on any confined Inflammable material such as a carpet or blanket.
- Do not place the product in a narrow space, as this may cause heat to buildup inside the product.

Failure to follow the above cautions may result in fire.

CAUTION**Do not place the product in direct sunshine and/or high temperature.**

Temperature build up inside the product may result in fire.

▲ CAUTION**Avoid placing in humid, smoky, vaporized or dusty places.**

This may result in fire and/or electric shock.

▲ CAUTION**Do not point the lens directly at the sun and/or intensive light such as direct sunlight, etc.**

Focusing of the light may cause eye injury and/or fire.

CAUTION**Ask your dealer to perform a periodical check and internal cleaning (approx. once every five years).**

Dust inside the product may result in fire. For check and cleaning cost, please consult your dealer.

Disclaimer

We disclaim any responsibility and shall be held harmless for any damages or losses incurred by the user in any of the following cases:

1. Fire, earthquake or any other act of God; acts by third parties; misuse by the user, whether intentional or accidental; use under extreme operating conditions.
2. Malfunction or non-function resulting in indirect, additional or consequential damages, including but not limited to loss of expected income and suspension of business activities.
3. Incorrect use not in compliance with instructions in this instruction manual.
4. Malfunctions resulting from misconnection to other equipment.
5. Repairs or modifications made by the user or caused to be made by the user and carried out by an unauthorized third party.
6. Notwithstanding the foregoing, Toshiba's/TAIS liabilities shall not, in any circumstances, exceed the purchase price of the product.

Copyright and Right of Portrait

There may be a conflict with the Copyright Law and other laws when a customer uses, displays, distributes, or exhibits an image picked up by the camera without permission from the copyright holder. Please also note that transfer of an image or file covered by copyright is restricted to use within the scope permitted by the Copyright Law. Customer is responsible for complying with all copyright laws.

Protection of Personal Information

Images taken by the camera that reveal the likeness of an individual person may be considered personal information. To disclose, exhibit or transmit those images over the internet or otherwise, consent of the person may be required.

Limitation of Usage

The product is not designed for any “critical applications.” “Critical applications” means life support systems, exhaust or smoke extraction applications, medical applications, commercial aviation, mass transit applications, military applications, homeland security applications, nuclear facilities or systems or any other applications where product failure could lead to injury to persons or less of life or catastrophic property damage. Accordingly, [Toshiba/TAIS] disclaims any and all liability arising out of the use of the product in any critical applications.

TABLE OF CONTENTS

<p>1. CAUTIONS ON USE AND INSTALLATION5</p> <p>2. COMPONENTS5</p> <p>3. NAMES AND FUNCTIONS6</p> <p>4. CONNECTION7</p> <p style="padding-left: 20px;">4.1 Standard Connection7</p> <p style="padding-left: 20px;">4.2 Cautions on Connection.....7</p> <p style="padding-left: 20px;">4.3 Connector Pin Assignments.....7</p> <p style="padding-left: 20px;">4.4 How to use “EMI core”8</p> <p>5. OPERATION9</p> <p style="padding-left: 20px;">5.1 White Balance.....9</p> <p style="padding-left: 20px;">5.2 Gain10</p> <p style="padding-left: 20px;">5.3 Shading Correction10</p> <p>6. ITEMS CONTROLLED BY THE SCREEN DISPLAY11</p> <p>7. MODE SETTING BY ON SCREEN DISPLAY12</p> <p style="padding-left: 20px;">7.1 Using the Menu12</p> <p style="padding-left: 20px;">7.2 Menu13</p> <p style="padding-left: 20px;">(1) SHUTTER (Electronic shutter).....13</p> <p style="padding-left: 40px;">(1.1) Changing the setting in MANU mode.....14</p> <p style="padding-left: 40px;">(1.2) Changing the setting in SS (synchro. scan) mode15</p> <p style="padding-left: 40px;">(1.3) Changing the setting in E. TRG mode16</p> <p style="padding-left: 40px;">(1.3.1) Changing the setting in 1P SNR mode16</p> <p style="padding-left: 40px;">(1.3.2) Changing the setting in 1P SR mode17</p> <p style="padding-left: 40px;">(1.3.3) Changing the setting in PW SNR mode18</p> <p style="padding-left: 40px;">(1.3.4) Changing the setting in PW SR mode.....19</p> <p style="padding-left: 40px;">(1.3.5) Changing the setting in RR mode.....19</p> <p style="padding-left: 40px;">(1.4) Changing each setting in AUTO mode20</p> <p style="padding-left: 20px;">(2) GAIN (Video gain).....20</p> <p style="padding-left: 40px;">(2.1) Changing the setting in GAIN.....20</p> <p style="padding-left: 20px;">(3) WHT BAL (White balance).....21</p> <p style="padding-left: 40px;">(3.1) Changing the setting in AWB (Automatic White Balance) mode...21</p> <p style="padding-left: 40px;">(3.2) Changing the setting in MANU (Manual) mode21</p>	<p style="padding-left: 20px;">(4) PROCESS22</p> <p style="padding-left: 40px;">(4.1) Changing gamma correction22</p> <p style="padding-left: 40px;">(4.2) Changing master pedestal22</p> <p style="padding-left: 40px;">(4.3) Changing R pedestal22</p> <p style="padding-left: 40px;">(4.4) Changing B pedestal.....22</p> <p style="padding-left: 40px;">(4.5) Changing noise reduction22</p> <p style="padding-left: 20px;">(5) SHADING.....23</p> <p style="padding-left: 40px;">(5.1) Changing V.SHAD. (Vertical Shading) correction mode24</p> <p style="padding-left: 40px;">(5.2) Changing the manual V.SHAD. (Vertical Shading) correction setting.....24</p> <p style="padding-left: 40px;">(5.3) Changing C.SHAD. (Corner Shading) correction mode24</p> <p style="padding-left: 40px;">(5.4) Changing the manual C.SHAD. (Corner Shading) correction setting24</p> <p style="padding-left: 20px;">(6) SYNC25</p> <p style="padding-left: 40px;">(6.1) Adjusting horizontal phase25</p> <p style="padding-left: 20px;">(7) OPTION25</p> <p style="padding-left: 40px;">(7.1) Changing serial communication baud rate25</p> <p style="padding-left: 20px;">(8) Returning to factory settings25</p> <p style="padding-left: 20px;">7.3 Synchro. Scan Operation26</p> <p style="padding-left: 40px;">(1) Setting by 1H26</p> <p style="padding-left: 40px;">(2) Setting by the frame.....26</p> <p style="padding-left: 20px;">7.4 E. TRG (External trigger)27</p> <p style="padding-left: 40px;">(1) 1P SNR (1 Pulse Trigger Sync Non Reset)27</p> <p style="padding-left: 80px;">(1.1) 1 Pulse Trigger SYNC-NON RESET Picture Output Timing27</p> <p style="padding-left: 40px;">(2) 1P SR (1 Pulse Trigger Sync Reset)28</p> <p style="padding-left: 80px;">(2.1) 1 Pulse Trigger SYNC-RESET Picture Output Timing28</p> <p style="padding-left: 40px;">(3) PW SNR (Pulse width trigger SYNC-NON RESET).....29</p> <p style="padding-left: 80px;">(3.1) Pulse Width Trigger SYNC-NON RESET Picture Output Timing29</p> <p style="padding-left: 40px;">(4) PW SR (Pulse width trigger SYNC-RESET).....30</p> <p style="padding-left: 80px;">(4.1) 1 Pulse Width Trigger SYNC-RESET Picture Output Timing30</p> <p style="padding-left: 40px;">(5) RR (Reset restart).....31</p> <p style="padding-left: 80px;">(5.1) Long Term Exposure31</p> <p style="padding-left: 80px;">(5.2) Input Timing Chart Example.....31</p>
--	---

7.5 Partial Read	32
(1) Partial Scanning OFF (All pixels scanning)	32
(2) Partial Scanning ON	32
(3) When Partial Scanning Mode is ON	32
7.6 Binning	33
7.7 External Sync	34
(1) External sync signal polarity	34
(2) External sync frequency range	34

(3) Using the unit with external sync signal ..	34
(3.1) H (horizontal) phase adjustment ..	34
8. INPUT OUTPUT SIGNAL SPECIFICATIONS	35
9. CCD OUTPUT WAVEFORM TIMING CHART	36
10. BEFORE MAKING A SERVICE CALL	37
11. SPECIFICATIONS	37
12. EXTERNAL APPEARANCE DIAGRAM	38

This product is a 3CCD color camera with digital video output.

1. CAUTIONS ON USE AND INSTALLATION

• Handling the unit.

Do not drop, jolt, or vibrate, as this may result in damage to the unit and may cause problems.

Treat the camera cables carefully to prevent cable problems, such as breaks in the cable and loose connections.

• Install the camera in a location free from noise.

If the camera or the cables are located near power utility lines or a TV, etc. undesirable noise may appear on the screen. In such a case, try to change the location of the camera or the cable wiring. Consult with a service personnel, if the noise still appears after changing the location or the cable wiring.

• Operating ambient temperature and humidity.

Do not use the camera in places where temperature and humidity exceed the specifications. Picture quality will deteriorate and internal parts may be damaged.

Be particularly careful when using in places exposed to direct sunlight. When shooting in hot environments, depending on the conditions of the object and the camera (for example when the gain is increased), noise in the form of vertical strips or white dots may occur. This is not a malfunction.

• When not using the camera for extended periods of time.

Switch the control unit off and disconnect the power supply.

• Avoid using or storing the camera in the following places:

Places filled with highly flammable and corrosive gas.

Places near gasoline, benzene, or paint thinner.

Places subject to strong vibration.

Places containing chemicals (such as pesticides), rubber or vinyl products for extended periods of time.

• Do not shoot intense light.

If there is an intense light at a location on the screen such as a spot light, a blooming and smearing may occur. When intense light enters, vertical stripes may appear on the screen. This is not a malfunction. Ghosts may occur when there is an intense light near the object. In this case, change the shooting angle.

• Moire

A moire pattern is an interference pattern generated when two repetitive line patterns overlap. This is not a malfunction. Eliminating the repetitive line patterns, or aligning the two patterns, will eliminate the moire.

• Handling of the protection cap.

Keep the protection cap away from children as they may pose a choking hazard. The protection cap protects the image sensing plane when the lens is removed from the camera head, do not discard.

• When cleaning the camera.

Unplug the power source before cleaning. Clean with a soft dry cloth only. Do not use chemicals or chemically treated cloths. Chemicals may damage coatings and printed letters. When cleaning the lens, use lens cleaning paper.

2. COMPONENTS

(1) Camera Control Unit	1
(2) Accessories	
(a) Instruction manual	1
(b) EMI core	1

3. NAMES AND FUNCTIONS

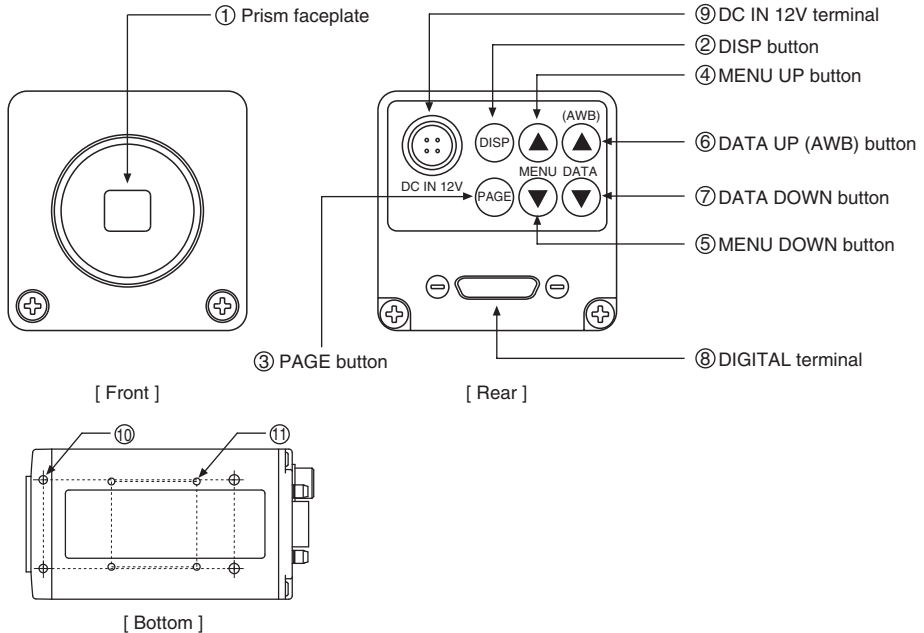

- | | |
|------------------------|--|
| ① Prism faceplate | The protection cap is attached on the lens mount portion. After removing the cap, mount the lens. Be careful not to scratch or touch the optical area. |
| ② DISP button | Used when switching the display. |
| ③ PAGE button | Used when switching to the menu and when selecting the menus. |
| ④ MENU UP button | Select the function to be confirmed or changed on the menu. |
| ⑤ MENU DOWN button | Select the function to be confirmed or changed on the menu. |
| ⑥ DATA UP (AWB) button | Changes the value of the function selected by the MENU (UP/DOWN) button. (Also used when using AWB.) |
| ⑦ DATA DOWN button | Changes the value of the function selected by the MENU (UP/DOWN) button. |
| ⑧ DIGITAL terminal | 8-bit RGB, digital signal, and sync signals are output in the Camera Link format. Trigger signal and external sync signal (HD, VD) are inputs. Mode switching signal for partial scanning is input. Accepts serial communication control signals and a DC power input (12V). |
| ⑨ DC IN 12V terminal | Accept a DC power input (12V). |
| ⑩ Mounting holes M3 | Used to mount the camera. |
| ⑪ Mounting holes M2 | Used to mount the camera. |

4. CONNECTION

4.1 Standard Connection

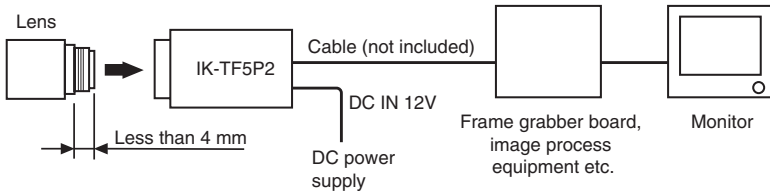

4.2 Cautions on Connection

- When connecting the camera cables, be sure to unplug the power source of the camera and the other equipment connected to it.
 - We suggest using a C mount lens made for a 3CCD color camera. When using another lens, the best camera performance of this camera may not be obtained. (For example, low resolution may occur, focus may be lost through the range of a zoom lens, and flare, ghost or shading may occur) Furthermore, in order to avoid damaging the mounting portion of the camera head, use a lens which has projection dimension from the mounting base of less than 0.157"(4mm).
 - The camera may be powered in two ways:
 - (1) Supplied to the DC IN 12V terminal
 - For DC power supply connecting to DC IN 12V terminal, use UL listed and/or CSA approved ungrounding type AC adaptor with the specifications described below.
 - Power supply voltage : DC12V±10%
 - Current rating : More than 830 mA
 - Ripple voltage : Less than 50 mV(p-p)
 - Connector : HR10A-7P-4S by HIROSE electronics Co. Ltd
 - Pins 1, 2 : 12V
 - Pins 3, 4 : GND
 - For DC power supply connecting to DC IN 12V terminal, use class 11 DC power supply approved according to EN60950-1 in Europe.
 - (2) Supplied to the DIGITAL terminal
 - Supply the DC power supply (DC10V-DC13V) to pins 1 and 26 of the cable (sold separately).
 - When using PoCL (power over camera link) to power the camera, use a standard PoCL cable.
- * Use power supply only one method at a time.

4.3 Connector Pin Assignments

DC IN 12V

1	+12V
2	+12V
3	GND
4	GND

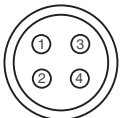

Connector used:
HR10A-7P-4PB
(HIROSE electronics
Co. Ltd) or equivalent.

DIGITAL

DIGITAL		Function		I/O
1	+12V	14	GND	-
2	X0-	15	X0+	O
3	X1-	16	X1+	O
4	X2-	17	X2+	O
5	Xclk-	18	Xclk+	O
6	X3-	19	X3+	O
7	SerTC+	20	SerTC-	Serial communication control (RXD)
8	SerTFG-	21	SerTFG+	Serial communication control (TXD) O
9	CC1-	22	CC1+	Trigger pulse input
10	CC2+	23	CC2-	Partial scanning control
11	CC3-	24	CC3+	External HD input
12	CC4+	25	CC4-	External VD input
13	GND	26	+12V	-

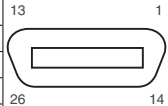

Connector used:
12226-51000-00
(3M) or equivalent.

4.4 How to use “EMI core”

EMI core is attached to this camera.

When the power is supplied from the DC IN terminal, this part is used like the following drawing.

If not used, an unnecessary radio wave may be emitted.

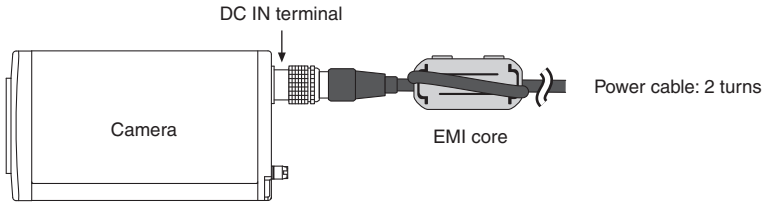

*** Mount this core as close as possible to the camera.**

5. OPERATION

- ① Refer to the item "4. CONNECTION", connect each component correctly.
- ② Turn on the power source of the connected equipment and the camera.
- ③ Point the lens at the object, adjust the lens iris, focus, etc..
- ④ Refer to the item "5.1 White Balance", to do the adjustment.
- ⑤ Refer to the items "5.2 Gain, 7. MODE SETTING BY ON SCREEN DISPLAY", select the necessary items.

5.1 White Balance

For the white balance adjustment of this unit, AWB (Automatic White Balance) and MANU (Manual white balance) adjustments are provided. To select the desired mode, refer to the items "7.2 (3) WHT BAL (White balance)" and "7. MODE SETTING BY ON SCREEN DISPLAY".

	AWB (Automatic White Balance)	MANU (Manual White Balance)
Outline	Adjust white balance by displaying the white object inside the area set by AWB menu and pressing the [DATA UP] button.	Adjust the white balance manually using the WHT BAL menu while shooting the white object.
Note	When the shutter mode is E.TRG, AWB is not available.	Adjustment is performed by confirming with a monitor etc.

- ① AWB (Automatic white balance)
 - Set the MODE to AWB on the WHT BAL menu.
Perform the C.TEMP (color temperature conversion) setting, if necessary.
(Refer to the item "7.2 (3) WHT BAL (White balance)".)
3200K : Appropriate for indoor shooting.
5600K : Appropriate for outdoor shooting.
 - If the index menu/menu is displayed, press the [DISP] button to disable the character display on the menu.
 - Shoot a known white object that fills the screen and push [DATA UP] button for approx. 1 second.
 - The character AWB blinks on the screen when the AWB starts.
 - The character AWB stops blinking when the AWB finishes, and the result is displayed for approx. 1 second.

Result displayed	Meaning
AWB OK	Automatic white balance adjustment finished correctly.
AWB NG LEVEL LOW	Automatic white balance adjustment cannot be performed because the video level is too low. Set the video level propely.
AWB NG LEVEL HIGH	Automatic white balance adjustment cannot be performed because the video level is too high. Set the video level propely.
AWB NG C. TEMP LOW	Automatic white balance adjustment cannot be performed because the color temperature is too low. If the C.TEMP is set to 5600K, set to 3200K. If the message appears with the C.TEMP set to 3200K, change the illumination or use a color temperature conversion filter.
AWB NG C. TEMP HIGH	Automatic white balance adjustment cannot be performed because the color temperature is too high. If the C.TEMP is set to 3200K, set to 5600K. If the message appears with the C.TEMP set to 5600K, change the illumination or use the color temperature conversion filter.
AWB NG NOT AVAILABLE	Automatic white balance adjustment cannot be performed because the shutter speed mode is E.TRG mode.
AWB NG	Automatic white balance adjustment cannot be performed for other reasons. Such as no white area is included in an object, etc.

② MANU (Manual white balance)

- Set the MODE to MANU on the WHT BAL menu.
(Refer to the item “7.2 (3) WHT BAL (white balance)”.)
- Shoot a known white object, adjust the white balance adjusting the levels of R GAIN and B GAIN on the menu, confirming with a monitor etc.
(Refer to the item “7.2 (3) (3.2) Changing each setting in MANU mode”.)

5.2 Gain

When the image is dark even if the lens iris is open, change the gain (video gain) to get the proper video level. For the gain adjustment of the unit, MANU (Manual) and OFF (0 dB) modes are provided. Select the mode on the GAIN menu. (Refer to the item “7.2 (2) GAIN (Video gain)”.)

① MANU (Manual gain)

Gain adjustment is performed on the GAIN menu. The adjustment range is from 0dB to 18dB in 1dB steps. (Refer to the item “7.2 (2) (2.1) (a) Changing the gain in MANU mode”.)

② OFF

Gain is fixed at 0 dB.

5.3 Shading Correction

Due to the lens used or the environmental condition, vertical color shading may occur at the top and bottom of the screen and at the corners. In this case, the shading correction can decrease the color shading. For the shading correction of the unit, MANU (Manual shading correction) and OFF (no shading correction) modes for V.SHAD. (Vertical Shading) and C.SHAD. (Corner Shading) are provided. Select the mode on the SHADING menu. (Refer to the “7.2 (5) (5.2) Changing the manual V.SHAD. (Vertical Shading) correction setting” and “7.2 (5) (5.4) Changing the manual C.SHAD. (Corner Shading) correction setting”.)

① MANU (Manual Shading)

Adjust the correction amount on the SHADING menu by confirming with a monitor or a waveform monitor.

② OFF

The status is no shading correction.

***The shading correction is effective when the lens iris or zoom ratio is fixed. Use the unit by setting V.SHAD. and C.SHAD. to OFF.**

6. ITEMS CONTROLLED BY THE SCREEN DISPLAY

	Item	Available selections	Preset value (Factory setting)	
Electronic shutter	MODE	MANU, SS, E. TRG, AUTO	MANU	
	E. TRG	1P SNR, 1P SR, PW SNR, PW SR, RR	1P SNR	
	MANU speed	OFF, 1/100s, 1/250s, 1/500s, 1/1000s, 1/2000s, 1/4000s, 1/10000s, 1/25000s, 1/50000s, 1/100000s	OFF	
	Syncro. scan.	Partial read OFF	1H/525H~524H/525H, OFF, 2FRM~512FRM	OFF
		Partial read 93fps	1H/340H~339H/340H, OFF, 2FRM~512FRM	
		Partial read 121fps	1H/260H~259H/260H, OFF, 2FRM~512FRM	
		Partial read 126fps	1H/250H~249H/250H, OFF, 2FRM~512FRM	
		Partial read 174fps	1H/181H~180H/181H, OFF, 2FRM~512FRM	
		Partial read 199fps	1H/158H~157H/158H, OFF, 2FRM~512FRM	
		Partial read 250fps	1H/126H~125H/126H, OFF, 2FRM~512FRM	
	Partial read / binning	Partial read	93fps, 121fps, 126fps, 174fps, 199fps, 250fps, E.93fps, E.121fps, E.126fps, E.174fps, E.199fps, E.250fps	OFF
		binning	ON, EXT ON	
		Trigger (1P SNR/SR)		
		Trigger (PW SNR/SR)		
	1P exposure time	0.01ms~16ms	16 ms	
	AUTO Level	-100~0~100	0	
	AUTO Peak/Average	00:10~05:05~10:00	05:05	
Gain	MODE	MANU, OFF	OFF	
	MANU	0dB~18dB	0dB	
White balance	MODE	AWB, MANU	AWB	
	Color temperature	3200K, 5600K	3200K	
	MANUAL R GAIN	-100~0~100	0	
	MANUAL B GAIN	-100~0~100	0	
	Process	GAMMA	ON, OFF	OFF
Master pedestal		-64~0~64	0	
R pedestal		-64~0~64	0	
B pedestal		-64~0~64	0	
NR		ON, OFF	OFF	
Shading	V. Shading correction mode	MANU, OFF	MANU	
	V. Shading manual correction MANU	-128~0~127	0	
	C. Shading correction mode	MANU, OFF	MANU	
	C. Shading manual correction			
	MANU R SIZE	0~63	0	
	MANU R GAIN	-32~0~31	0	
	MANU R POSI	-32~0~31	0	
	MANU B SIZE	0~63	0	
	MANU B GAIN	-32~0~31	0	
MANU B POSI	-32~0~31	0		
Sync	H phase adjustment	-100~0~100	0	
Option	Baud rate	9600 bps, 19200 bps	9600 bps	

7. MODE SETTING BY ON SCREEN DISPLAY

Various settings can be controlled on the unit by using the on screen menu displayed on the monitor. The contents once set are memorized even if the power source is turned off, so it is unnecessary to set again when using the unit next time. When the setting is performed, select the menu of the item to be set. (Use the monitor available to display an image with higher signal format than VGA.)

7.1 Using the Menus

When the power is turned on, the normal screen showing only the video signal appears. Change the output to each screen (video signal output, Index menu, and menus) by using the [DISP], [PAGE], [MENU UP], [MENU DOWN], [DATA UP], and [DATA DOWN] buttons.

* A menu is selected when pushing the [PAGE] button after moving the “→” on the screen by the [MENU UP], [MENU DOWN] button while the Index menu is displayed.

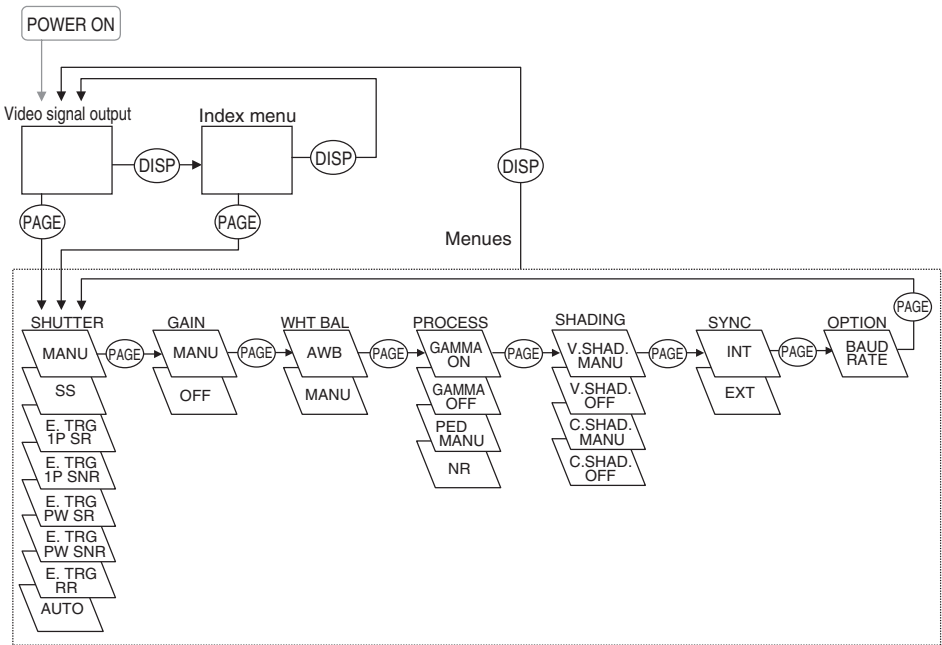

7.2 Menus

- Select the menu to change the setting by referring to the item "7.1 Using the Menus".
- When the [MENU UP], [MENU DOWN] buttons are pushed, the "→" on the screen moves up and down. Move the "→" to the item whose setting you wish to change.

Note:

When performing the mode setting in the menu display while selecting ON in "PART" (Partial Read: refer to page 32), E.TRG in "MODE" and "BNGG" (Binning: refer to page 33), the screen display and camera operation switch to normal mode. After closing the MENU, it returns to the previous mode.

(1) SHUTTER (Electronic shutter)

The electronic shutter has four modes; MANU (Manual), SS (Synchro. Scan), E.TRG (External trigger), and AUTO (Auto Shutter).

Move the "→" to "MODE" and push [DATA UP], [DATA DOWN] button to select the desired mode among "MANU", "SS", "E.TRG", and "AUTO".

MANUAL : It is possible to select the exposure time from eleven speed setting; OFF, 1/100s, 1/250s, 1/500s, 1/1000s, 1/2000s, 1/4000s, 1/10000s, 1/25000s, 1/50000s, 1/100000s.
When not using the electronic shutter, select OFF.

Note:

When setting a rapid shutter speed, sensitivity degrades according to the speed.

When a discharging light such as fluorescent lamp, etc. is used for the illumination, the flicker may be excessive.

SS : Shutter speed can be set by the horizontal scanning time (1H) unit or by the number of frames.

E.TRG : Exposure is performed and images are output by external trigger. E.TRG includes the five modes described below. (For details of specifications, refer to the item "7.4 E.TRG (External trigger)".)

- **1P SNR (1 Pulse Sync Non Reset)**

The charge begins to accumulate to each CCD pixels after the trigger pulse is received, and 1 frame images are output according to the internal vertical sync signal timing. The exposure/accumulation time can be set from 0.01 to 16 ms. The trigger signal timing can be set to either the rising or falling edge.

- **1P SR (1 Pulse Sync Reset)**

The charge begins to accumulate to each CCD pixels after the trigger pulse is received.

Upon completion of accumulation the vertical sync signal is reset and 1 frame images are output. The exposure/accumulation time can be set from 0.01 to 16 ms. The trigger signal timing can be set to either the rising or falling edge.

- **PW SNR (Pulse width trigger Sync Non Reset)**

The charge begins to accumulate to each CCD pixels after the trigger pulse is received, and 1 frame images are output according to the internal vertical sync signal timing. This is the mode to set the exposure period by the pulse width of the trigger. The trigger signal polarity can be set to either the positive or negative polarity.

- **PW SR (Pulse width trigger Sync Reset)**

The charge begins to accumulate to each CCD pixels after the trigger pulse is received.

Upon completion of accumulation the vertical sync signal is reset and 1 frame images are output. This is the mode to set the exposure period by the pulse width of the trigger.

The trigger signal polarity can be set to either the positive or negative polarity.

- **RR (Reset restart)**

Input of an external reset-restart signal permits one screen of information to be output at an arbitrary timing.

AUTO : Exposure time is automatically controlled to obtain the specified video level.

(1. 1) Changing the setting in MANU mode

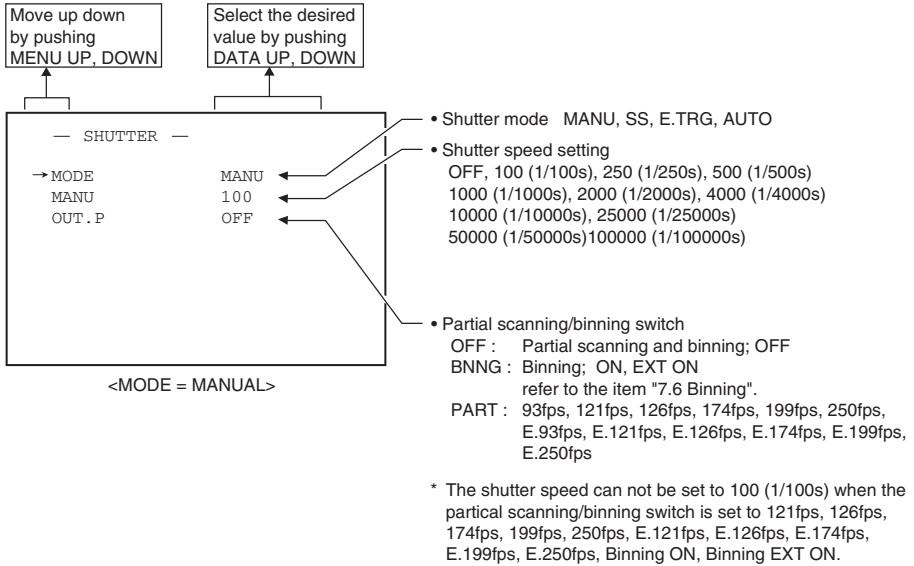

(a) Changing the shutter speed

- ① Move the "→" to MANU by pushing [MENU UP], [MENU DOWN] buttons.
- ② Select the shutter speed by pushing [DATA UP], [DATA DOWN] buttons.

(b) Partial scanning/binning setting

- ① Move the "→" to OUT.P by pushing [MENU UP], [MENU DOWN] buttons.
- ② Select the mode by pushing [DATA UP], [DATA DOWN] buttons.
- ③ Move "→" to the current value by pushing [MENU UP], [MENU DOWN] buttons.
- ④ Select a desired settings by pushing [DATA UP], [DATA DOWN] buttons.

* The preset value of partial scanning/binning is not displayed, when OUT.P is OFF.

(1. 2) Changing the setting in SS (synchro. scan) mode

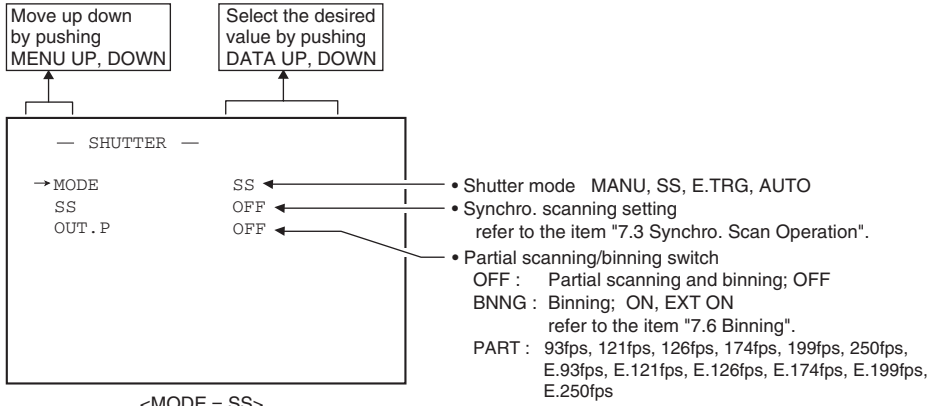

(a) Changing the shutter speed setting

- ① Move the "→" to SS by pushing [MENU UP], [MENU DOWN] buttons.
- ② Select the shutter speed by pushing [DATA UP], [DATA DOWN] buttons.

(b) Partial scanning/binning setting

- ① Move the "→" to OUT.P by pushing [MENU UP], [MENU DOWN] buttons.
- ② Select the mode by pushing [DATA UP], [DATA DOWN] buttons.
- ③ Move "→" to the current value by pushing [MENU UP], [MENU DOWN] buttons.
- ④ Select a desired settings by pushing [DATA UP], [DATA DOWN] buttons.

* The preset value of partial scanning/binning is not displayed, when OUT.P is OFF.

Note:

The slow shutter speed may increase the fixed pattern noise and/or the white pixels. This is a characteristic of CCD, and is not a symptom of malfunction.

(1.3) Changing the setting in E.TRG mode

The E.TRG has five modes; 1P SNR, 1P SR, PW SNR, PW SR, RR.

First move the "→" to MODE and select E. TRG, then move the "→" to E. TRG and select the desired E. TRG mode.

(1.3.1) Changing the setting in 1P SNR mode

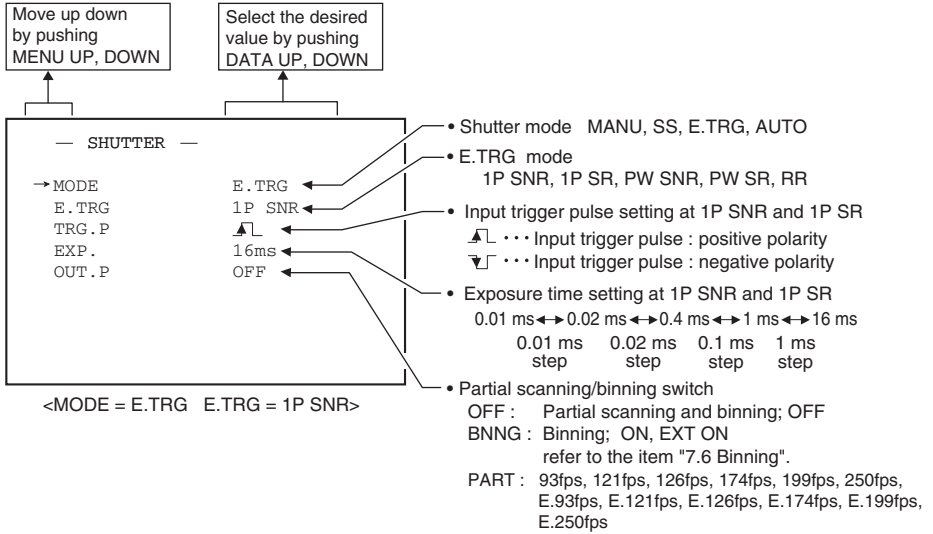

(a) Changing the polarity of the input trigger pulse setting

- ① Move the "→" to TRG.P by pushing [MENU UP], [MENU DOWN] buttons.
- ② Select either ▲ ▭ or ▼ ▭ by pushing [DATA UP], [DATA DOWN] buttons.

(b) Changing 1P SNR exposure time setting

- ① Move the "→" to EXP. by pushing [MENU UP], [MENU DOWN] buttons.
- ② Select the exposure time by pushing [DATA UP], [DATA DOWN] buttons.

(c) Changing the partial scanning/binning setting

- ① Move the "→" to OUT.P by pushing [MENU UP], [MENU DOWN] buttons.
- ② Select the mode by pushing [DATA UP], [DATA DOWN] buttons.
- ③ Move "→" to the current value by pushing [MENU UP], [MENU DOWN] buttons.
- ④ Select a desired settings by pushing [DATA UP], [DATA DOWN] buttons.

* The preset value of partial scanning/binning is not displayed, when OUT.P is OFF.

(1.3.2) Changing the setting in 1P SR mode

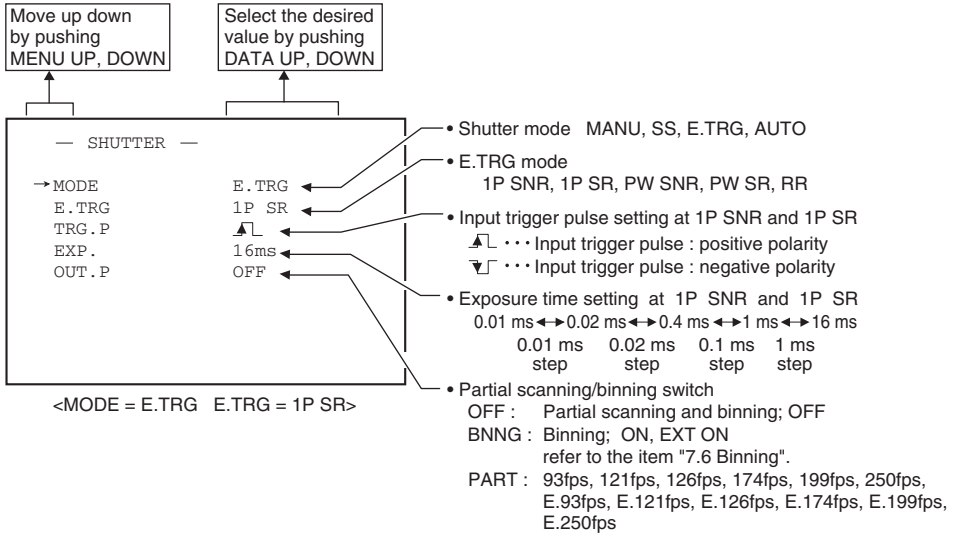

(a) Changing the polarity of the input trigger pulse setting

- ① Move the "→" to TRG.P by pushing [MENU UP], [MENU DOWN] buttons.
- ② Select either ▲, ▼, by pushing [DATA UP], [DATA DOWN] buttons.

(b) Changing 1P SR exposure time setting

- ① Move the "→" to EXP. by pushing [MENU UP], [MENU DOWN] buttons.
- ② Select the exposure time by pushing [DATA UP], [DATA DOWN] buttons.

(c) Changing the partial scanning/binning setting

- ① Move the "→" to OUT.P by pushing [MENU UP], [MENU DOWN] buttons.
- ② Select the mode by pushing [DATA UP], [DATA DOWN] buttons.
- ③ Move "→" to the current value by pushing [MENU UP], [MENU DOWN] buttons.
- ④ Select a desired settings by pushing [DATA UP], [DATA DOWN] buttons.

* The preset value of partial scanning/binning is not displayed, when OUT.P is OFF.

(1.3.3) Changing the setting in PW SNR mode

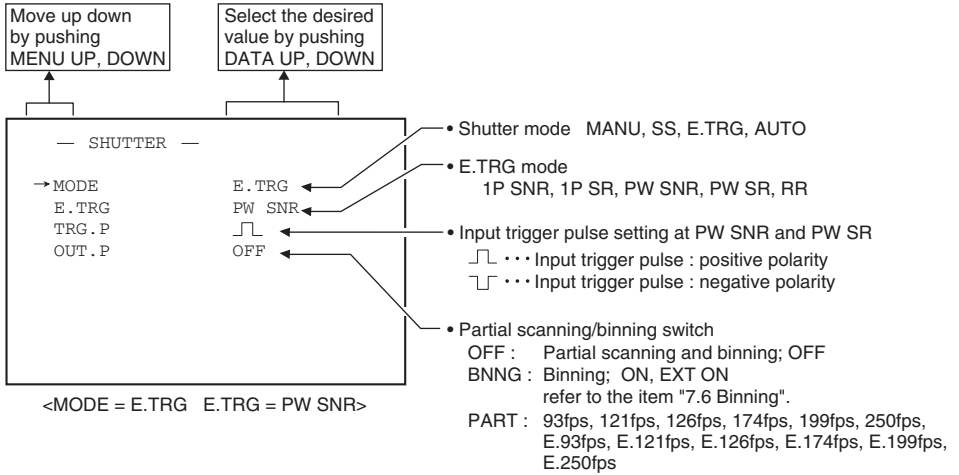

(a) Changing the polarity of the input trigger pulse setting

- ① Move the "→" to TRG.P by pushing [MENU UP], [MENU DOWN] buttons.
- ② Select either ⌋⌋, ⌋⌋ by pushing [DATA UP], [DATA DOWN] buttons.

(b) Changing the partial scanning/binning setting

- ① Move the "→" to OUT.P by pushing [MENU UP], [MENU DOWN] buttons.
- ② Select the mode by pushing [DATA UP], [DATA DOWN] buttons.
- ③ Move "→" to the current value by pushing [MENU UP], [MENU DOWN] buttons.
- ④ Select a desired settings by pushing [DATA UP], [DATA DOWN] buttons.

* The preset value of partial scanning/binning is not displayed, when OUT.P is OFF.

Note:

The longer the storage time with extended exposures, the more visible certain characteristics of CCD cameras become: fixed pattern noise, white pixels, etc.

(1.3.4) Changing the setting in PW SR mode

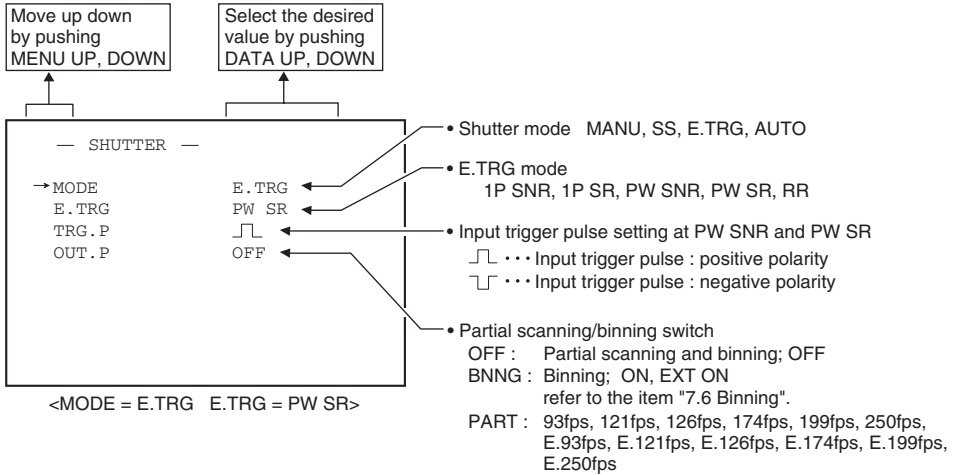

(a) Changing the polarity of the input trigger pulse setting

- ① Move the "→" to TRG.P by pushing [MENU UP], [MENU DOWN] buttons.
- ② Select either [Pulse waveform], [Pulse waveform] by pushing [DATA UP], [DATA DOWN] buttons.

Note:

The longer the storage time with extended exposures, the more visible certain characteristics of CCD cameras become: fixed pattern noise, white pixels, etc.

(1.3.5) Changing the setting in RR mode

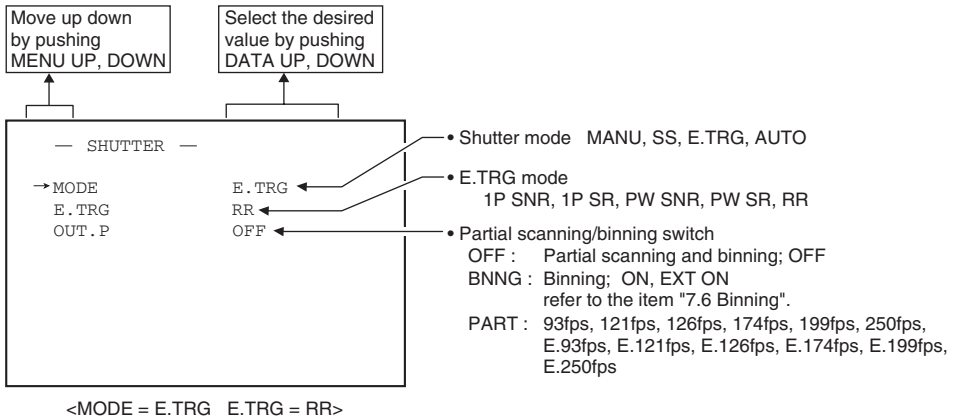

(a) Changing the partial scanning/binning setting

- ① Move the "→" to OUT.P by pushing [MENU UP], [MENU DOWN] buttons.
- ② Select the mode by pushing [DATA UP], [DATA DOWN] buttons.

Note:

The longer the storage time with extended exposures, the more visible certain characteristics of CCD cameras become: fixed pattern noise, white pixels, etc.

(1.4) Changing each setting in AUTO mode

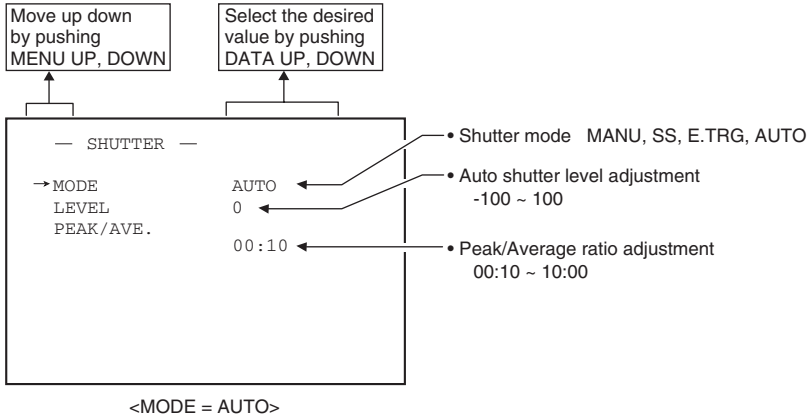

(a) Changing the AUTO shutter level

- ① Move the “→” to LEVEL by pushing [MENU UP], [MENU DOWN] buttons.
- ② Select the shutter level by pushing [DATA UP], [DATA DOWN] buttons.

(b) Changing the auto shutter detection (PEAK/AVE. ratio)

- ① Move the “→” to PEAK/AVE. by pushing [MENU UP], [MENU DOWN] buttons.
- ② Select the PEAK/AVE. ratio by pushing [DATA UP], [DATA DOWN] buttons.

(2) GAIN (Video gain)

When the image is dark even if the lens iris is open, change the gain (video gain) to get the proper video level. For the gain adjustment of the unit, MANU (Manual) and OFF (0dB) modes are provided.

- ① MANU (Manual gain)
Gain adjustment is performed on the GAIN menu. The adjustment range is from 0dB to 18dB in 1dB steps.
- ② OFF
Gain is fixed at 0dB.

Move the “→” to MODE, push the [DATA UP], [DATA DOWN], and select one of the two modes between MANU and OFF.

(2.1) Changing the setting in GAIN

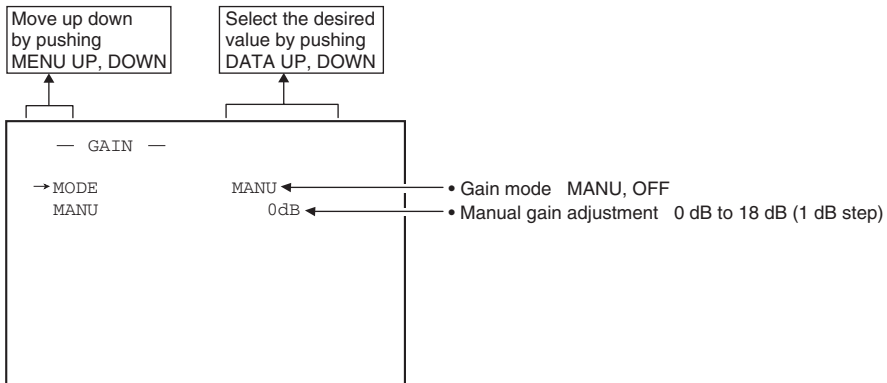

(a) Changing the gain in MANU mode

- ① Move the “→” to MANU by pushing [MENU UP], [MENU DOWN] buttons.
- ② Adjust the manual gain by pushing [DATA UP], [DATA DOWN] buttons.

(3) WHT BAL (White balance)

WHT BAL has two modes; AWB, MANU.

Move the “→” to MODE, push the [DATA UP], [DATA DOWN], and select one of the two modes between AWB and MANU.

(3. 1) Changing the setting in AWB (Automatic White Balance) mode

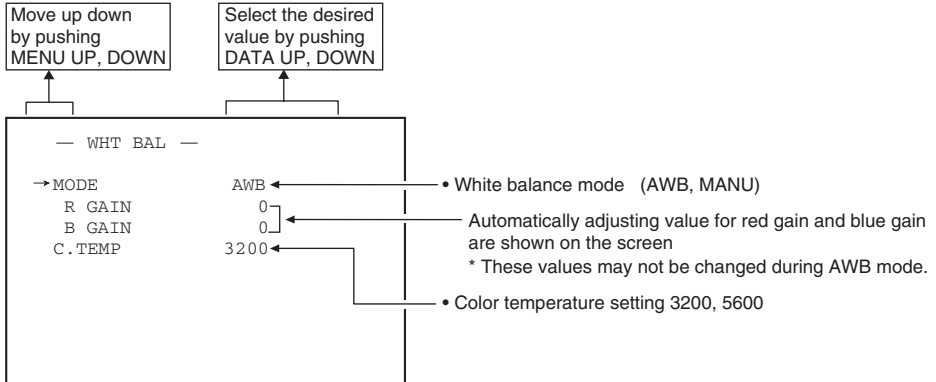

(a) Changing color temperature setting

- ① Move the “→” to C.TEMP by pushing [MENU UP], [MENU DOWN] buttons.
- ② Select either 3200 or 5600 by pushing [DATA UP], [DATA DOWN] buttons.

(3. 2) Changing the setting in MANU (Manual) mode

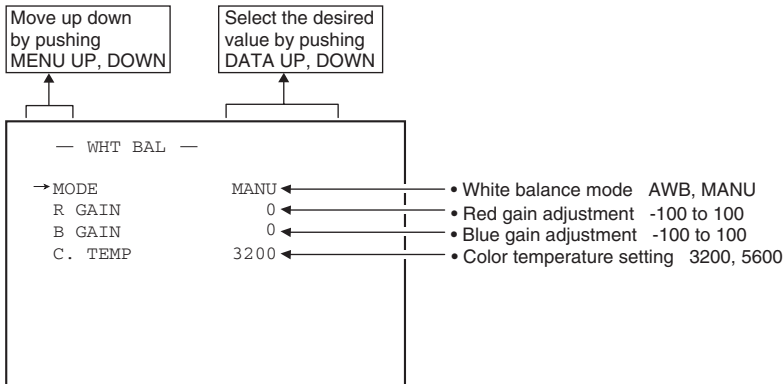

(a) Changing the red gain

- ① Move the “→” to R GAIN by pushing [MENU UP], [MENU DOWN] buttons.
- ② Adjust the red gain by pushing [DATA UP], [DATA DOWN] buttons.

(b) Changing the blue gain

- ① Move the “→” to B GAIN by pushing [MENU UP], [MENU DOWN] buttons.
- ② Adjust the blue gain by pushing [DATA UP], [DATA DOWN] buttons.

(4) PROCESS

- Gamma Correction (GAMMA)
Select either OFF or ON of Gamma Correction.
- Master Pedestal (M. PED)
Adjust the Pedestal level of each RGB.
- R Pedestal (R. PED)
Adjust the Pedestal level of Red.
- B Pedestal (B. PED)
Adjust the Pedestal level of Blue.
- Noise Reduction
Select either OFF or ON of Noise Reduction.

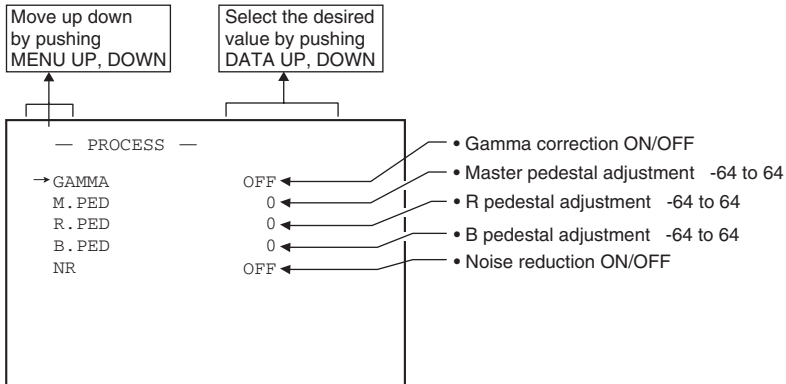

(4.1) Changing gamma correction

- ① Move the "→" to GAMMA by pushing [MENU UP], [MENU DOWN] buttons.
- ② Select the gamma correction by pushing [DATA UP], [DATA DOWN] buttons.

(4.2) Changing master pedestal

- ① Move the "→" to M. PED by pushing [MENU UP], [MENU DOWN] buttons.
- ② Adjust the master pedestal by pushing [DATA UP], [DATA DOWN] buttons.

(4.3) Changing R pedestal

- ① Move the "→" to R. PED by pushing [MENU UP], [MENU DOWN] buttons.
- ② Adjust the R pedestal by pushing [DATA UP], [DATA DOWN] buttons.

(4.4) Changing B pedestal

- ① Move the "→" to B. PED by pushing [MENU UP], [MENU DOWN] buttons.
- ② Adjust the B pedestal by pushing [DATA UP], [DATA DOWN] buttons.

(4.5) Changing noise reduction

- ① Move the "→" to NR by pushing [MENU UP], [MENU DOWN] buttons.
- ② Select the noise reduction by pushing [DATA UP], [DATA DOWN] buttons.

(5) SHADING

Due to the lens used or the environmental condition, vertical color shading may occur at the top and bottom of the screen and at the corners. In this case, the shading correction can decrease the color shading. For the shading correction of the unit, you can select among MANU (Manual shading correction) or OFF (no shading correction) for V.SHAD. (Vertical Shading) and C.SHAD. (Corner Shading).

① MANU (Manual Shading correction)

Adjust the correction amount on the SHADING menu by confirming with a monitor or a waveform monitor.

- R size (R SIZE) low ↔ high
Adjust the red correction area of the corner. 0 ↔ 63
- R gain (R GAIN) low ↔ high
Adjust the red correction level. -32 ↔ 31
- R position (R POSI) Left low ↔ Right low
Adjust the red correction area on left and right side. -32 ↔ 31
- B size (B SIZE)
Adjust the blue correction area of the corner.
- B gain (B GAIN)
Adjust the blue correction level.
- B position (B POSI)
Adjust the blue correction area on left and right side.

② OFF

The status is no shading correction.

***The shading correction is effective when the lens iris or zoom ratio is fixed. Use the unit by setting V.SHAD and C.SHAD. to OFF.**

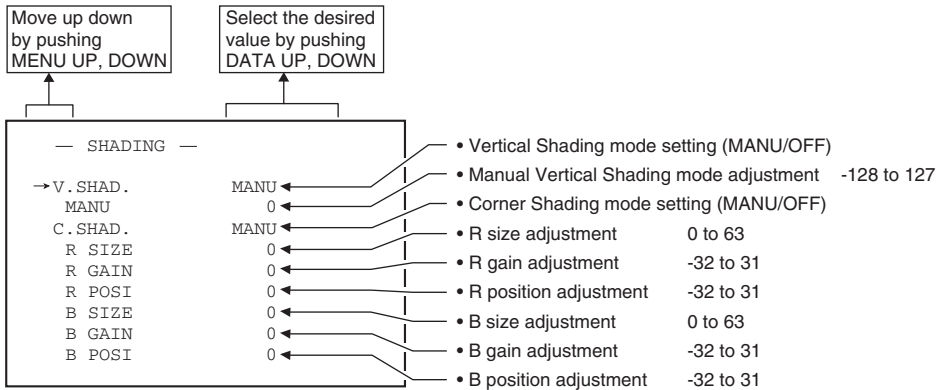

(5. 1) Changing V.SHAD. (Vertical Shading) correction mode

- ① Move the “→” to V.SHAD by pushing [MENU UP], [MENU DOWN] buttons.
- ② Select the V.SHAD. mode setting by pushing [DATA UP], [DATA DOWN] buttons.

Note:

The alignment value for vertical shading is fixed to “0” when selecting V.SHAD. OFF. MANU is not displayed in the menu.

(5. 2) Changing the manual V.SHAD. (Vertical Shading) correction setting

- ① Move the “→” to MANU by pushing [MENU UP], [MENU DOWN] buttons.
- ② Adjust the MANU V.SHAD. by pushing [DATA UP], [DATA DOWN] buttons.

(5. 3) Changing C.SHAD. (Corner Shading) correction mode

- ① Move the “→” to C.SHAD by pushing [MENU UP], [MENU DOWN] buttons.
- ② Select the C.SHAD. mode setting by pushing [DATA UP], [DATA DOWN] buttons.

Note:

The alignment value for corner shading is fixed to “0” when selecting C.SHAD. OFF. MANU is not displayed in the menu.

(5. 4) Changing the manual C.SHAD. (Corner Shading) correction setting

(a) Changing the red size setting

- ① Move the “→” to R SIZE by pushing [MENU UP], [MENU DOWN] buttons.
- ② Adjust the R size by pushing [DATA UP], [DATA DOWN] buttons.

(b) Changing the red gain setting

- ① Move the “→” to R GAIN by pushing [MENU UP], [MENU DOWN] buttons.
- ② Adjust the R gain by pushing [DATA UP], [DATA DOWN] buttons.

(c) Changing red position setting

- ① Move the “→” to R POSI by pushing [MENU UP], [MENU DOWN] buttons.
- ② Adjust the R position by pushing [DATA UP], [DATA DOWN] buttons.

(d) Changing blue size setting

- ① Move the “→” to B SIZE by pushing [MENU UP], [MENU DOWN] buttons.
- ② Adjust the B size by pushing [DATA UP], [DATA DOWN] buttons.

(e) Changing blue gain setting

- ① Move the “→” to B GAIN by pushing [MENU UP], [MENU DOWN] buttons.
- ② Adjust the B gain by pushing [DATA UP], [DATA DOWN] buttons.

(f) Changing blue position setting

- ① Move the “→” to B POSI by pushing [MENU UP], [MENU DOWN] buttons.
- ② Adjust the B position by pushing [DATA UP], [DATA DOWN] buttons.

(6) SYNC

When an external sync signal is input, the display menu changes from INT (internal sync) to EXT (external sync) automatically.

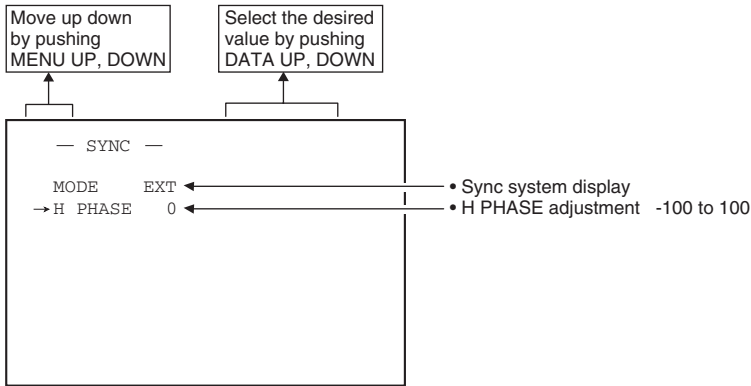

(6.1) Adjusting horizontal phase

- ① Move the "→" to H PHASE by pushing [MENU UP], [MENU DOWN] buttons.
- ② Adjust the horizontal phase by pushing [DATA UP], [DATA DOWN] buttons.

(7) OPTION

(7.1) Changing serial communication baud rate

- ① Move the "→" to BAUD RATE by pushing [MENU UP], [MENU DOWN] buttons.
- ② Select either 9600 or 19200 by pushing [DATA UP], [DATA DOWN] buttons.

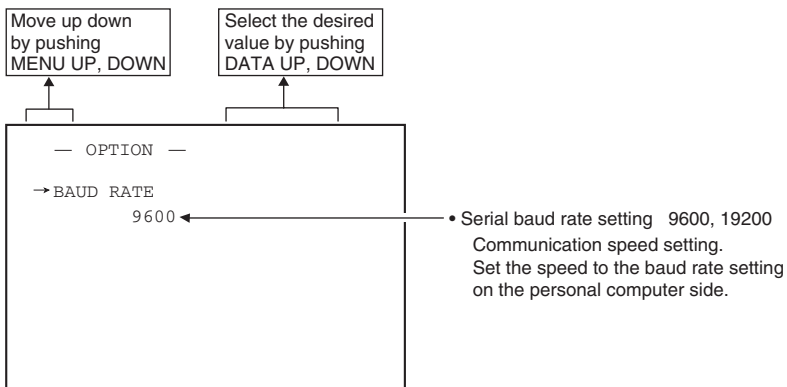

(8) Returning to factory settings

All the settings can be returned to the factory default status (preset status).

- (1) If characters are displayed on the screen, press the [DISP] button to disable the character display.
- (2) Push [MENU DOWN] and [DATA DOWN] buttons simultaneously for approx. 1 second.
- (3) The preset operation starts. When the preset operation finishes, the character PRESET OK is displayed for approx. 1 second.

7.3 Synchro. Scan Operation

The shutter speed can be set by the horizontal scanning period (1H) or by the number of frames.

(1) Setting by 1H

1H/525H ~ 524H/525H stands for the setting by the 1H and the shutter speed can be set by the 1H (31.8 μ s).
 When operating Partial Scanning or binning, the number's listed below can be used for setting.

Partial scanning/binning OFF	1H/525H ~ 524H/525H
Partial scanning 93fps, E.93fps	1H/340H ~ 339H/340H
Partial scanning 121fps, E.121fps	1H/260H ~ 259H/260H
Partial scanning 126fps, E.126fps	1H/250H ~ 249H/250H
Partial scanning 174fps, E.174fps	1H/181H ~ 180H/181H
Partial scanning 199fps, E.199fps	1H/158H ~ 157H/158H
Partial scanning 250fps, E.250fps	1H/126H ~ 125H/126H
binning	1H/263H ~ 262H/263H

(2) Setting by the frame

2FRM to 512FRM stand for the setting (long period exposure) by the frame.

The video signal stored during the frame period set is output as 1 frame video image at a frame interval specified.

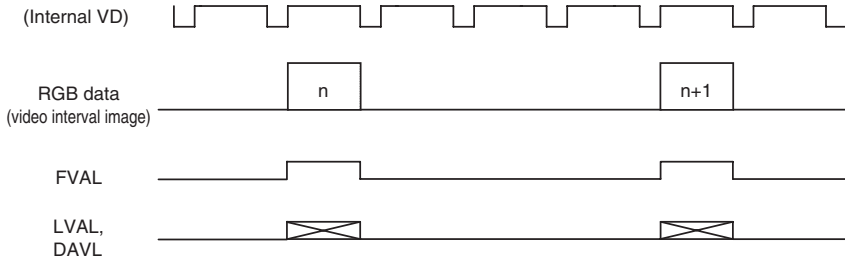

(4FRM setting)

7.4 E. TRG (External trigger)

Charge begins to accumulate after the trigger input to CC1 of the DIGITAL terminal, and 1 frame images are output. There are four modes: 1P SNR, 1P SR, PW SNR, PW SR.

(1) 1P SNR (1 Pulse Trigger Sync Non Reset)

Charge begins to accumulate after the trigger input to CC1 of the DIGITAL terminal, and 1 frame images are output.

(1.1) 1 Pulse Trigger SYNC-NON RESET Picture Output Timing

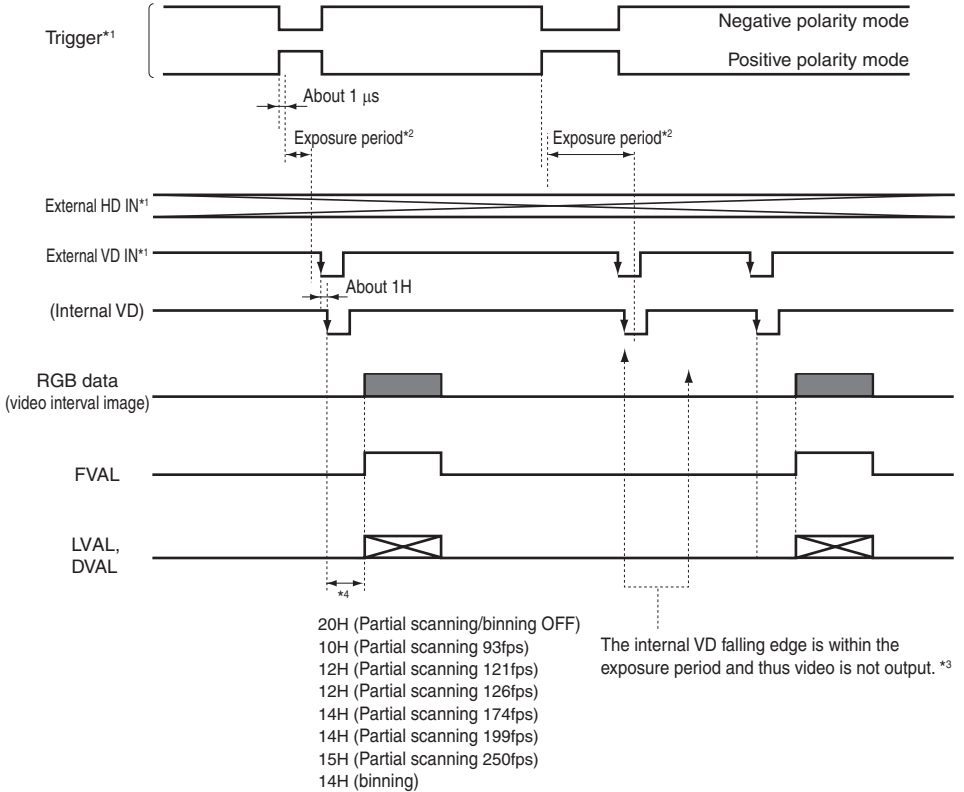

*1: External input signal

*2: Exposure time is determined by the setting of "7.2 (1.3) Changing each setting in E.TRG mode".

*3: Video is output at the falling edge of the internal VD following completion of the exposure period.

The video and FVAL/LVAL/DVAL have a paired relationship.

*4: When NR is set to ON, 1H is increased.

Note:

When the next trigger is input before completion of the output of the video corresponding to the trigger, there will be an effect on the video.

(2) 1P SR (1 Pulse Trigger Sync Reset)

Charge begins to accumulate after the trigger input to CC1 of the DIGITAL terminal, the vertical sync signal is reset and frame images are output.

(2.1) 1 Pulse Trigger SYNC-RESET Picture Output Timing

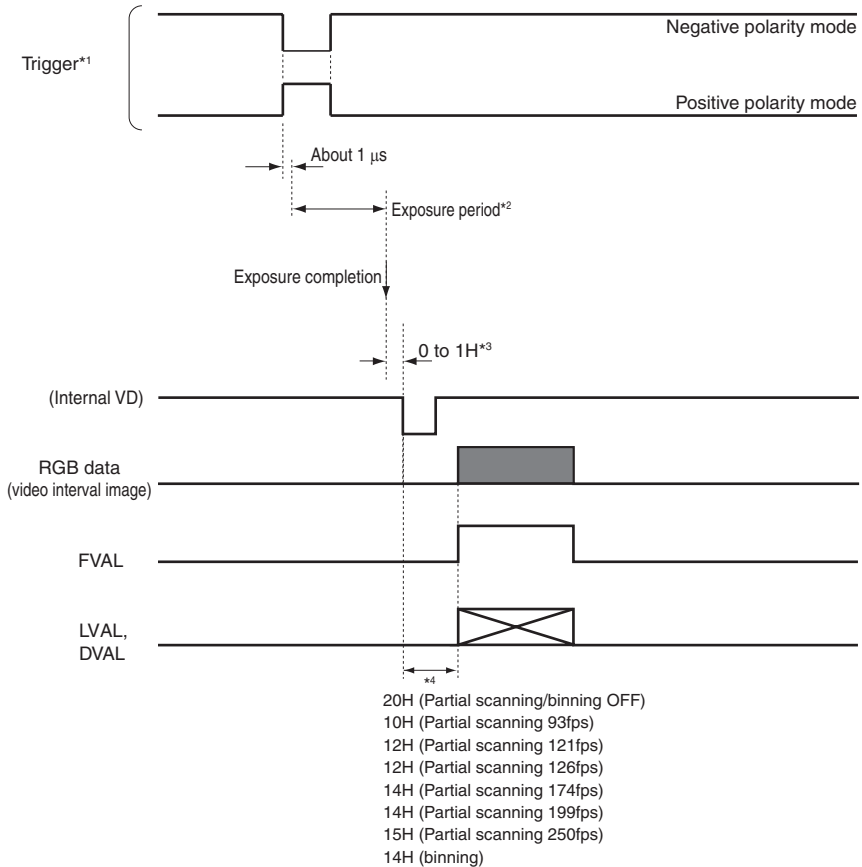

*1: External input signal

*2: Exposure time is determined by the setting of "7. 2 (1.3) Changing each setting in E.TRG mode".

*3: VD is generated after 0 to 1H following the completion of the exposure period and the video is synchronized to this and output.

*4: When NR is set to ON, 1H is increased.

Note:

When the next trigger is input before completion of the output of the video corresponding to the trigger, there will be an effect on the video.

(3) PW SNR (Pulse width trigger SYNC-NON RESET)

The trigger input to CC1 of the DIGITAL terminal develops 1 frame images.

(3. 1) Pulse Width Trigger SYNC-NON RESET Picture Output Timing

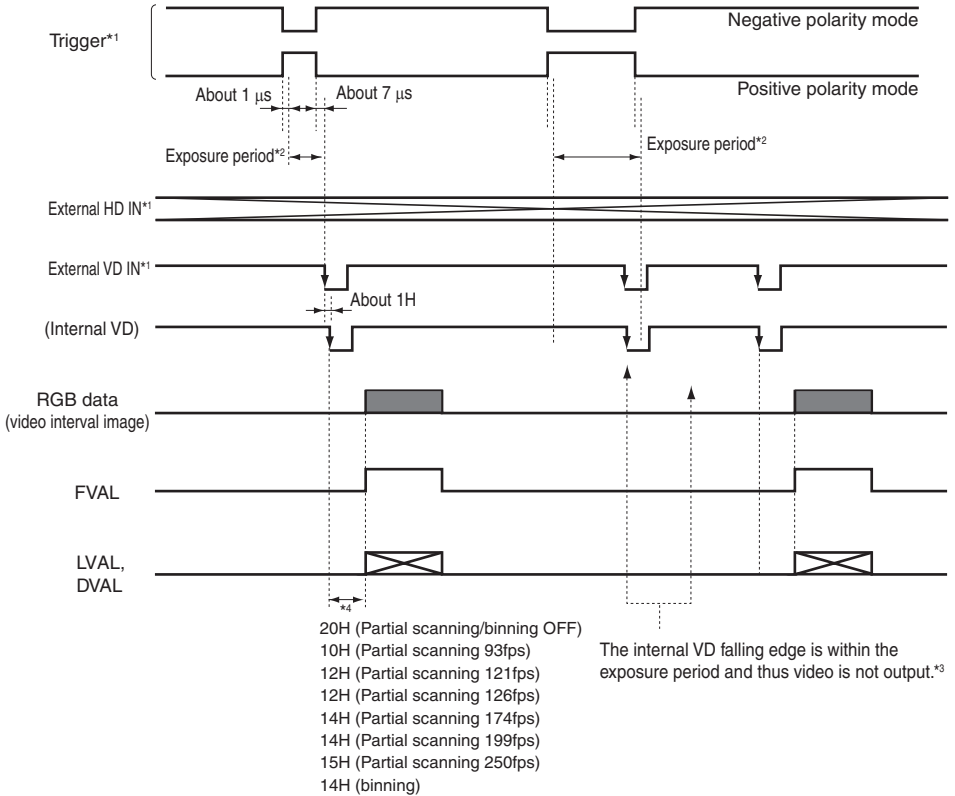

*1: External input signal

*2: Exposure time = Trigger pulse width + 6 μ s

(Valid trigger pulse width is 2 μ s or greater for external trigger shutter operation.)

*3: Video is output at the falling edge of the internal VD following completion of the exposure period.

The video and FVAL/LVAL/DVAL have a paired relationship.

*4: When NR is set to ON, 1H is increased.

Note:

When the next trigger is input before completion of the output of the video corresponding to the trigger, there will be an effect on the video.

(4) PW SR (Pulse width trigger SYNC-RESET)

The trigger input to the CC1 of the DIGITAL terminal develops 1 frame images.

(4. 1) 1 Pulse Width Trigger SYNC-RESET Picture Output Timing

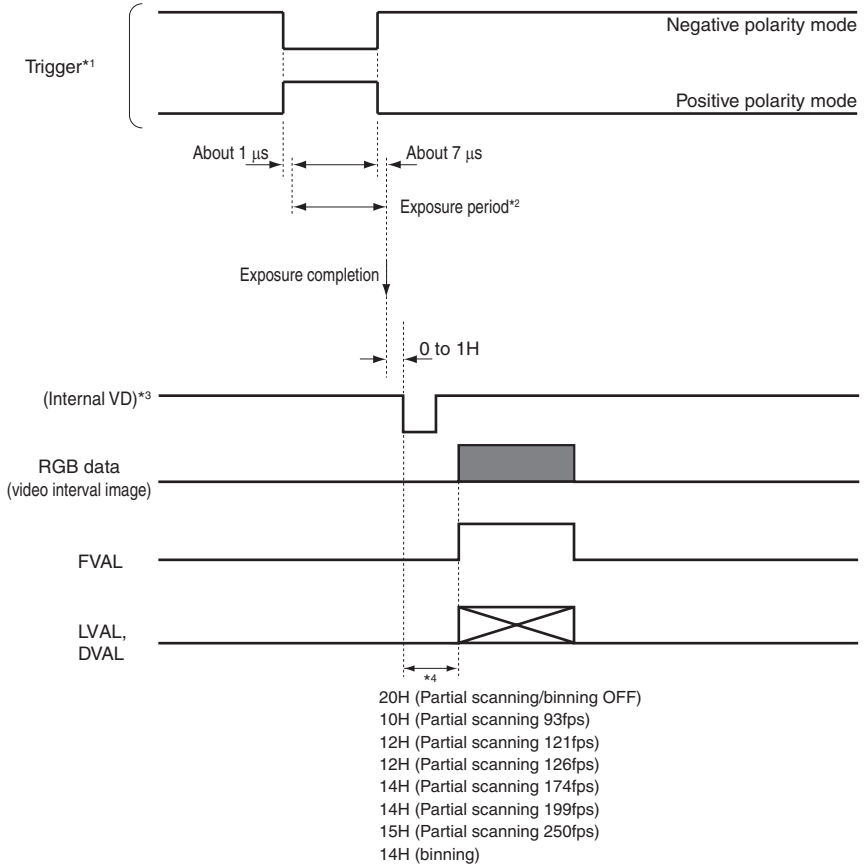

*1: External input signal

*2: Exposure time = Trigger pulse width + 6 μ s

(Valid trigger pulse width is 2 μ s or greater for external trigger shutter operation.)

*3: VD is generated after 0 to 1H following the completion of the exposure period and the video is synchronized to this and output.

*4: When NR is set to ON, 1H is increased.

Note:

When the next trigger is input before completion of the output of the video corresponding to the trigger, there will be an effect on the video.

(5) RR (Reset restart)

Input of an external reset-restart signal (CC4 of the DIGITAL terminal: External VD input) permits one screen of information to be output at an arbitrary timing.

(5.1) Long Term Exposure

When sufficient sensitivity is not obtained under normal operating conditions or capturing the trail of a moving object is desired, the reset-restart function allows high-sensitivity images by extending the exposure time. To achieve this, please input (from an external source) a VD signal that has an expanded VD pulse and VD pulse interval.

(5.2) Input Timing Chart Example

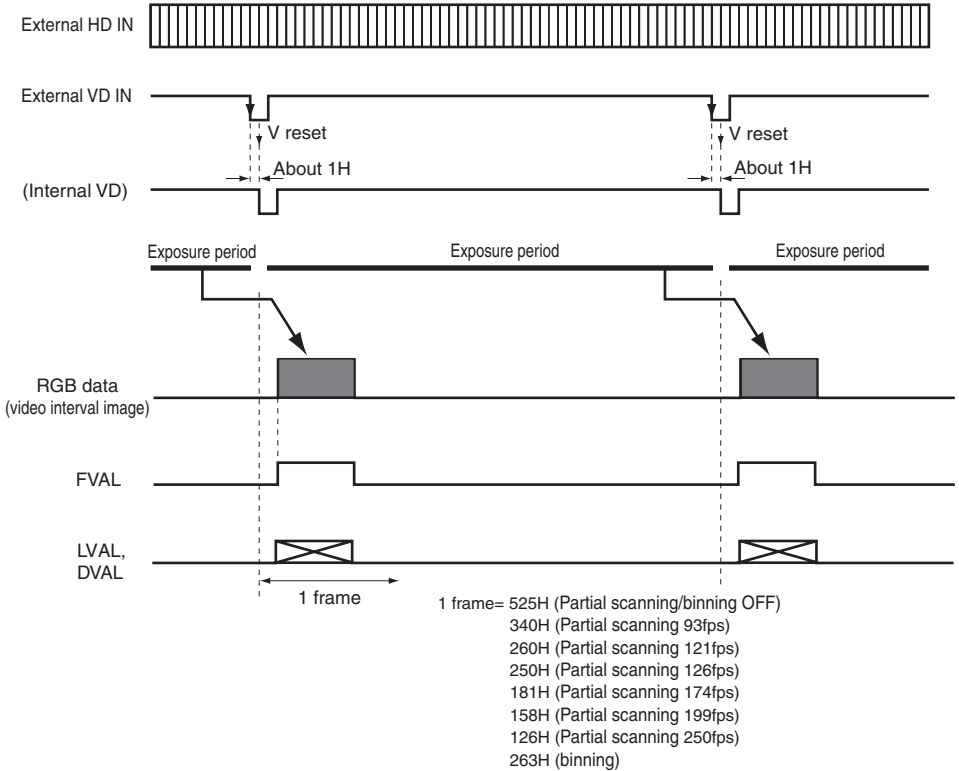

Note:

External VD interval: more than 1 frame

7.5 Partial Read

(1) Partial Scanning OFF (All pixels scanning)

In this mode, every pixels independent signal is output from the DIGITAL connector each 1/60s.

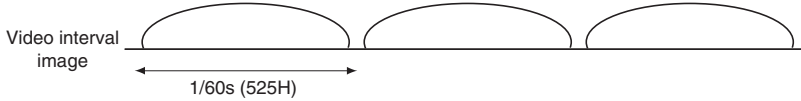

(2) Partial Scanning ON

In this mode, the pixel signal of the vertical center portion of the image is output from the DIGITAL connector.

In the E.**fps mode, the partial scanning and all the pixels scanning can be switched by the DIGITAL terminal (CC2: partial scanning control signal).

CC2	E.93fps	E.121fps	E.126fps	E.174fps	E.199fps	E.250fps
'L'	Partial scanning 93fps	Partial scanning 121fps	Partial scanning 126fps	Partial scanning 174fps	Partial scanning 199fps	Partial scanning 250fps
'H'	All pixels scanning	All pixels scanning	All pixels scanning	All pixels scanning	All pixels scanning	All pixels scanning

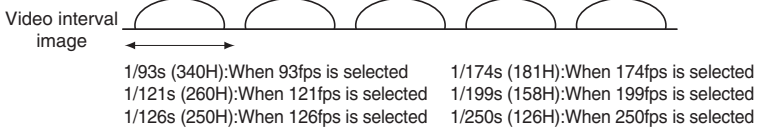

(3) When Partial Scanning Mode is ON

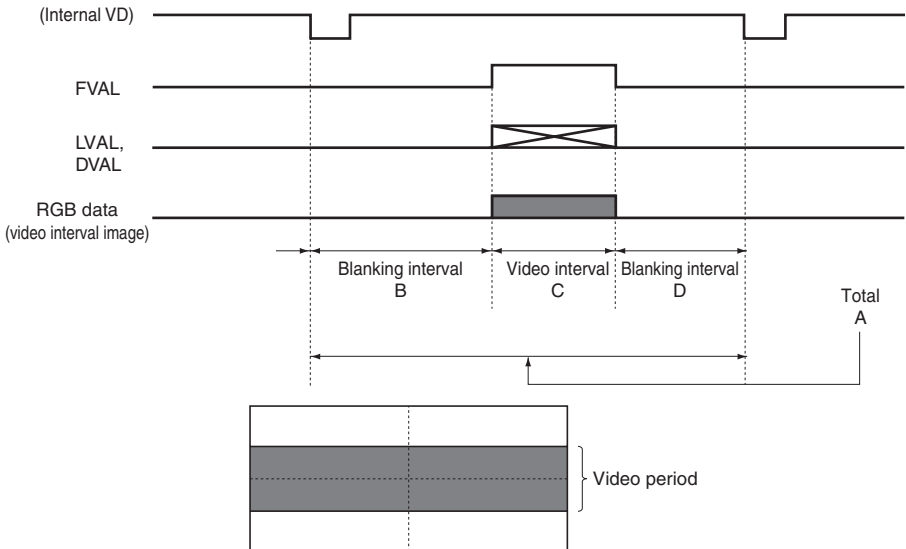

Mode	Total A	Blanking interval B	Video interval C	Blanking interval D
93fps	340H	10H	324H	6H
121fps	260H	12H	240H	8H
126fps	250H	12H	230H	8H
174fps	181H	14H	158H	9H
199fps	158H	14H	134H	10H
250fps	126H	15H	100H	11H

7.6 Binning

In this mode, all the image on the image sensing area is output with its frame rate being higher by combining every two lines into one.

The binning mode can be set by switching “OUT. P” to “BNNG” on the -SHUTTER- menu.

ON : Switches to the binning mode.

EXT.ON : The binning/all pixels scanning can be controlled by CC2 of the DIGITAL terminal.

CC2 “L” : binning

CC2 “H” : All pixels scanning

When binning Mode is ON

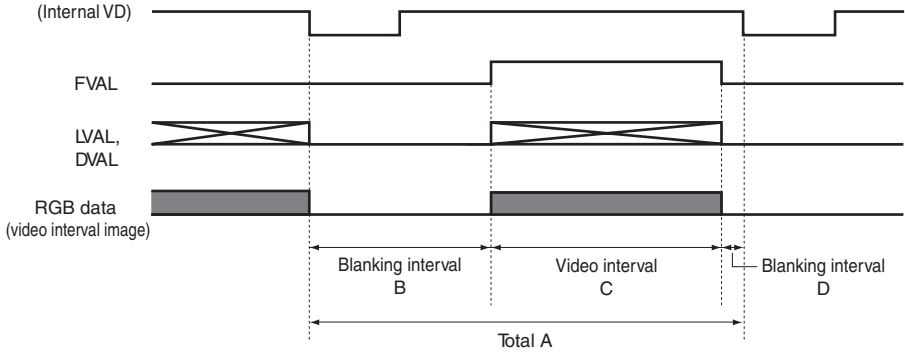

	Total A	Blanking interval B	Video interval C	Blanking interval D
Binning	263H	14H	246H	3H

7.7 External Sync

When using the unit with an external sync signal, input HD and VD to CC3 and CC4 of the DIGITAL terminal. When the external sync signal is input, the camera automatically switches its sync from the internal sync to the external sync.

The operation is as shown below, depending on the unit's status and how external sync signals are input.

Shutter mode	HD input	VD input	Note
At time of SYNC-NON RESET mode	N	N	Internal sync mode
	Y	Y	External sync mode
	N	Y	Only V reset is applied due to VD input. Normally not used.
	Y	N	HD is synchronized to external, but video is not output because there is no VD input. Normally not used.
At time of SYNC-RESET mode	N	*	Internal sync mode. The presence of VD is ignored, and after a specified time after a trigger input, V reset is applied.
	Y	*	HD is synchronized to external. The presence of VD is ignored, and after a specified time after a trigger input, V reset is applied.
At time of reset restart	Y	Y	HD is synchronized to external. Video is output due to VD input.
	N	Y	HD is synchronized to the inside of the camera. Video is output due to VD input.
	*	N	Video is not output because there is no VD input. Normally not used.
At time of manual shutter	N	N	Internal sync mode
	Y	Y	External sync mode
	Y	N	HD is synchronized to external. Normally not used.
	N	Y	Disabled

* Either Y or N is permitted.

(1) External sync signal polarity

HD: 2 to 5V(p-p) Negative

VD: 2 to 5V(p-p) Negative

(2) External sync frequency range

(External sync with HD, VD)

Within $\pm 1\%$ (at horizontal sync frequency of 31.469 kHz)

(3) Using the unit with external sync signal

When adjusting H (horizontal) phase refer to the item "7.2 (6) (6.1) Adjusting horizontal phase".

(3.1) H (horizontal) phase adjustment

Observe the external sync signal and the LVAL signal output waveform of the unit with a dual trace oscilloscope, and adjust H phase so that the H phases match.

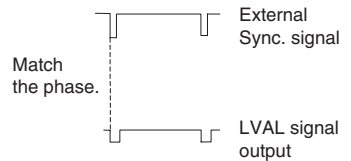

8. INPUT OUTPUT SIGNAL SPECIFICATIONS

(1) HD Input Specifications

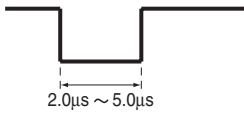

(2) VD Input Specifications

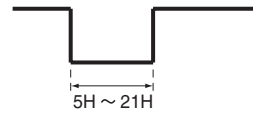

(3) Trigger Pulse Specifications

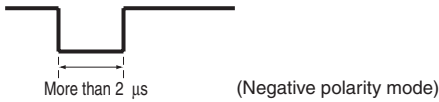
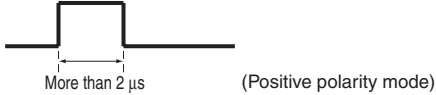

(4) External HD/VD Input Phase Specifications

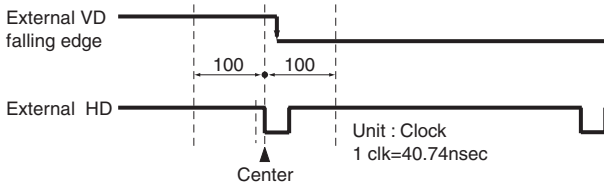

The phase relationship of the external HD and VD should correspond to the center phase (i.e., the external HD falling edge) as illustrated in the above diagram.

External VD falling edge:

Please input within about 100 clock cycles of the standard center phase.

Note that V sync of the video is output with a delay of about 2H from the external VD at the time of reset-restart and the external trigger mode.

In the normal mode:

Continuously with the HD period of $31.78\mu\text{s}$ and VD period of 16.68ms (partial scanning 93fps: 10.80ms , 121fps: 8.26ms , 126fps: 7.94ms , 174fps: 5.75ms , 199fps: 5.02ms , 250fps: 4.00ms , binning: 8.36ms).

Phase timing is as illustrated in the above diagram (with only the falling edge applicable).

In the reset-restart/external trigger mode:

Continuously with the HD period of $31.78\mu\text{s}$. VD (reset) is at an arbitrary timing with the phase of HD being within the standard of the above diagram.

9. CCD OUTPUT WAVEFORM TIMING CHART

(1) Horizontal Output Waveform Timing Chart

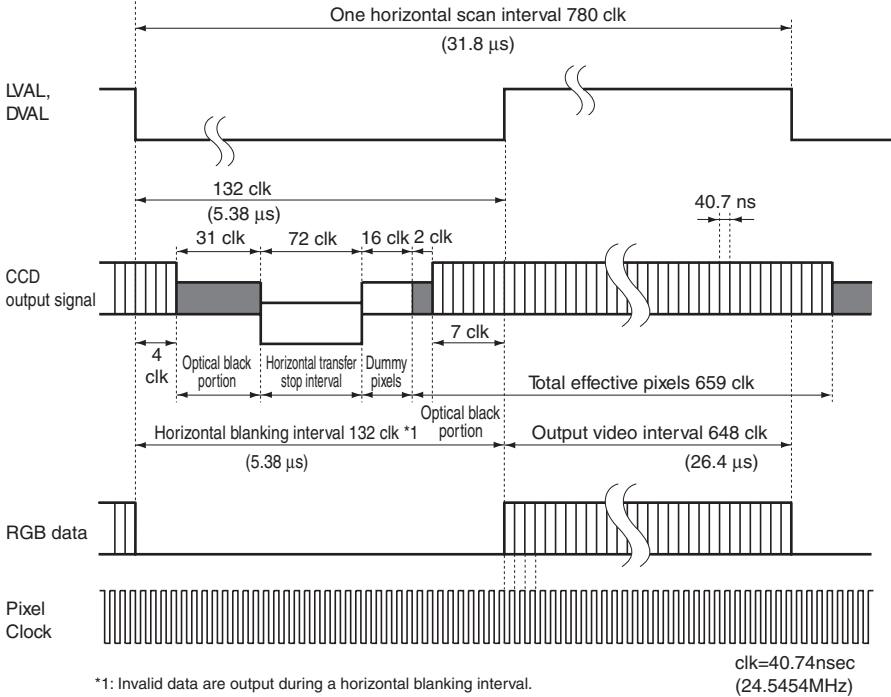

(2) Vertical Output Waveform Timing Chart

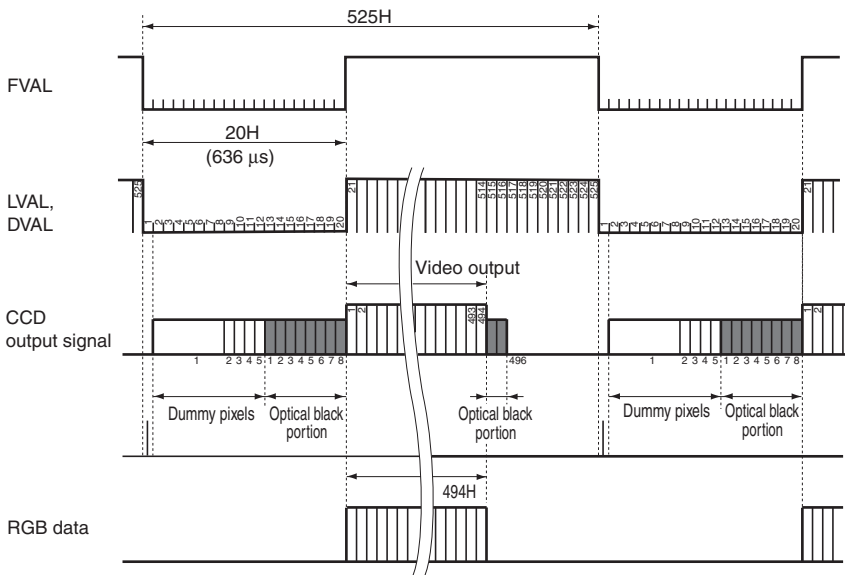

10. BEFORE MAKING A SERVICE CALL

Symptom	Items to be checked
No image	<ul style="list-style-type: none"> • Is the power supplied correctly? • Is the lens iris adjusted correctly? • Are the cables connected correctly? • Is the shutter mode set correctly? • Is the image process equipment set correctly?
Poor color	<ul style="list-style-type: none"> • Is the monitor adjusted correctly? • Is the white balance of the camera adjusted correctly? • Is there enough illumination?

11. SPECIFICATIONS

Power supply	DC 10V ~ DC 13.2V
Power consumption	Approx. 3.4W (When the DC power supply is 12V)
Pick-up system	RGB, 3CCD
Image sensor	1/3inch All pixels CCD (Effective pixels Horizontal : 659, Vertical : 494)
Scanning System	Progressive scan
Video output pixels	Horizontal pixels : 659, Vertical : 494
Pixel clock frequency	24.5454MHz
Sync signal frequency	Horizontal : 31.469kHz, Vertical : 59.94Hz
Sync system	Internal/External (Automatic switching)
Sensitivity	F6.8 standard (2000 lx, 3000K)
Minimum illumination	14 lx (F2.2, Sensitivity + 18 dB, 3000K)
Lens mount	C mount (flange back : 17.526 mm in-air)
Ambient temperature	0 to 40°C (32 to 104°F)
Ambient humidity	Less than 90%
Weight	Approx. 158g (0.338lbs)
External dimension	44 (W) x 44 (H) x 78 (D) mm (1.73" (W) x 1.73" (H) x 3.07" (D)) (except for protruded portion)
White balance	AWB (Automatic white balance), MANUAL (Manual)
Gain	MANUAL (Manual), OFF (0 dB)
Partial scanning	93fps, 121fps, 126fps, 174fps, 199fps, 250fps
binning	ON, EXT ON
Output signal	8-bit RGB, Digital output (Camera Link format)
Sync signal output	FVAL, LVAL, DVAL (Positive polarity) Pixel Clock
External sync input	HD : CC3 (LVDS input) Negative polarity VD : CC4 (LVDS input) Negative polarity
External trigger input	CC1 (LVDS input), More than 2 μs pulse width
Partial scanning control signal input	CC2 (LVDS input)
Interface	Serial data interface : Ser TC (RXD), Ser TFG (TXD)

The designs and specifications are subject to change without notice.
If any change occurs, we will revise the manual, etc.

12. EXTERNAL APPEARANCE DIAGRAM

Unit : mm [inch]

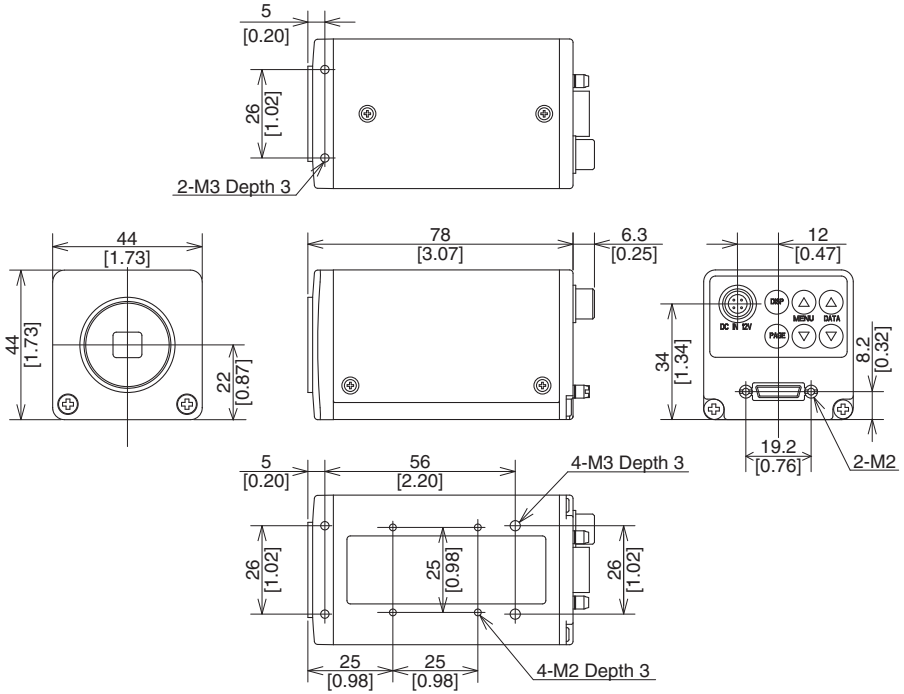

* inch=mm/25.4

Limited Warranty – TOSHIBA CCD Camera

The Imaging Systems Division of Toshiba America Information Systems, Inc. ("ISD") makes the following limited warranty with regard to this CCD Camera ("Product"). These limited warranties apply to the Original End-User ("You").

One (1) Year Limited Warranty of Labor and Parts

ISD warrants that this Product will perform in accordance with specifications for a period of one (1) year from the date of purchase by the Original End-User. During this one (1) year period, ISD will repair or replace the Product, if it does not perform as warranted. In order to take advantage of this Limited Warranty, You must: (a) deliver the Product to an ISD Authorized Service Provider ("ASP"); and (b) pay all transportation and insurance charges for shipment of the Product to the ASP. ISD reserves the right to substitute factory refurbished parts in place of those in need of repair.

Instruction Manual (Owner's Manual):

You should read the Instruction Manual (Owner's Manual) thoroughly before operating this Product. Before seeking warranty service, you should check the troubleshooting guide in the Instruction Manual (Owner's Manual) and follow the instructions to correct the problem.

Your Responsibilities

This Limited Warranty is subject to the following conditions:

1. You must provide the bill of sale or proof of purchase at the time that warranty service is required.
2. You must notify an ASP within thirty (30) days after You discover that the Product does not perform in accordance with specifications during the Limited Warranty period.
3. All warranty servicing of this product must be made by an ISD Authorized Service Provider.
4. You must pack the Product in its original carton using the original packing material, then insert the original carton containing the Product into another carton with additional packing material before shipping the Product to an ASP.

DISCLAIMERS:

ALL OTHER EXPRESS OR IMPLIED WARRANTIES ON THIS PRODUCT, INCLUDING THE IMPLIED WARRANTIES OF MERCHANTABILITY AND FITNESS FOR A PARTICULAR PURPOSE, ARE HEREBY DISCLAIMED. SOME STATES DO NOT ALLOW THE EXCLUSION OF IMPLIED WARRANTIES OR LIMITATIONS ON HOW LONG AN IMPLIED WARRANTY LASTS, SO THE ABOVE LIMITATIONS MAY NOT APPLY TO YOU.

IF THIS PRODUCT IS NOT IN GOOD WORKING ORDER AS WARRANTED ABOVE, YOUR SOLE AND EXCLUSIVE REMEDY SHALL BE THE REPAIR OR REPLACEMENT OF THE PRODUCT. IN NO EVENT WILL ISD OR ITS PARENT COMPANY OR ANY ASP BE LIABLE TO YOU OR ANY THIRD PARTY FOR ANY DAMAGES IN EXCESS OF THE PURCHASE PRICE OF THE PRODUCT. THIS LIMITATION APPLIES TO DAMAGES OF ANY KIND, INCLUDING ANY DIRECT OR INDIRECT DAMAGES, LOST PROFITS, LOST SAVINGS OR OTHER SPECIAL, INCIDENTAL, EXEMPLARY OR CONSEQUENTIAL DAMAGES, WHETHER FOR BREACH OF CONTRACT, TORT OR OTHERWISE, OR WHETHER ARISING OUT OF THE USE OF OR INABILITY TO USE SUCH PRODUCT, EVEN IF ISD, ITS PARENT COMPANY, OR AN ASP HAS BEEN ADVISED OF THE POSSIBILITY OF SUCH DAMAGES OR OF ANY CLAIM BY ANY OTHER PARTY. SOME STATES DO NOT ALLOW THE EXCLUSION OR LIMITATION OF INCIDENTAL OR CONSEQUENTIAL DAMAGES FOR SOME PRODUCTS, SO THE ABOVE LIMITATIONS OR EXCLUSIONS MAY NOT APPLY TO YOU.

THIS LIMITED WARRANTY GIVES YOU SPECIFIC LEGAL RIGHTS, AND YOU MAY ALSO HAVE OTHER RIGHTS WHICH MAY VARY FROM STATE TO STATE.

THIS LIMITED WARRANTY SHALL BE VOID IF THE PRODUCT OR PARTS HAVE BEEN SUBJECTED TO MISUSE, ABUSE, ACCIDENT, IMPROPER INSTALLATION, IMPROPER MAINTENANCE, OR USE IN VIOLATION OF ISD'S WRITTEN INSTRUCTIONS, OR WHERE THE PRODUCT HAS BEEN ALTERED OR MODIFIED WITHOUT ISD'S PRIOR AUTHORIZATION, OR UPON THE REMOVAL OR ALTERATION OF ISD'S FACTORY SERIAL NUMBER. LABOR SERVICE CHARGES FOR PRODUCT INSTALLATION, SET UP AND ADJUSTMENT OF CONTROLS ARE NOT COVERED BY THIS LIMITED WARRANTY.

How to Obtain Warranty Service – Step-By-Step Procedures:

To obtain warranty service, You should:

1. Contact an ASP for warranty service within thirty (30) days after the Product fails to comply with specifications.
2. Arrange for shipment of the Product to an ASP.
3. Securely pack the Product as described above, insure the carton, and include a letter explaining the problem and a copy of the bill of sale or proof of purchase.
4. Prepay all transportation and insurance costs.

Questions? If you have any questions, please check ISD's Web Site for support and a current e-mail contact to where you can send e-mails:

Web Site: <http://www.toshibacameras.com/>

No person, agent, distributor, dealer, authorized service provider, or company is authorized to change, modify, or extend the terms of this Limited Warranty in any manner whatsoever. The time within which an action must be commenced to enforce any obligation of ISD arising under this Limited Warranty or under any statute, or law of the United States or any state thereof, is hereby limited to one (1) year from the date You discover or should have discovered the problem. This limitation does not apply to implied warranties arising under state law. Some states do not permit limitation of the time within which You may bring an action beyond the limits provided by state law, so the above provision may not apply to You. This Limited Warranty gives You specific legal rights and You may also have other rights which vary from state to state.

TOSHIBA AMERICA INFORMATION SYSTEMS, INC.

Imaging Systems Division

9740 Irvine Boulevard, Irvine, CA 92618-1697

Copyright© 2012 Toshiba America, Inc. All rights reserved.

TOSHIBA